

Modalità di impostazione setting mode

G. INITIAL SETTING MODE

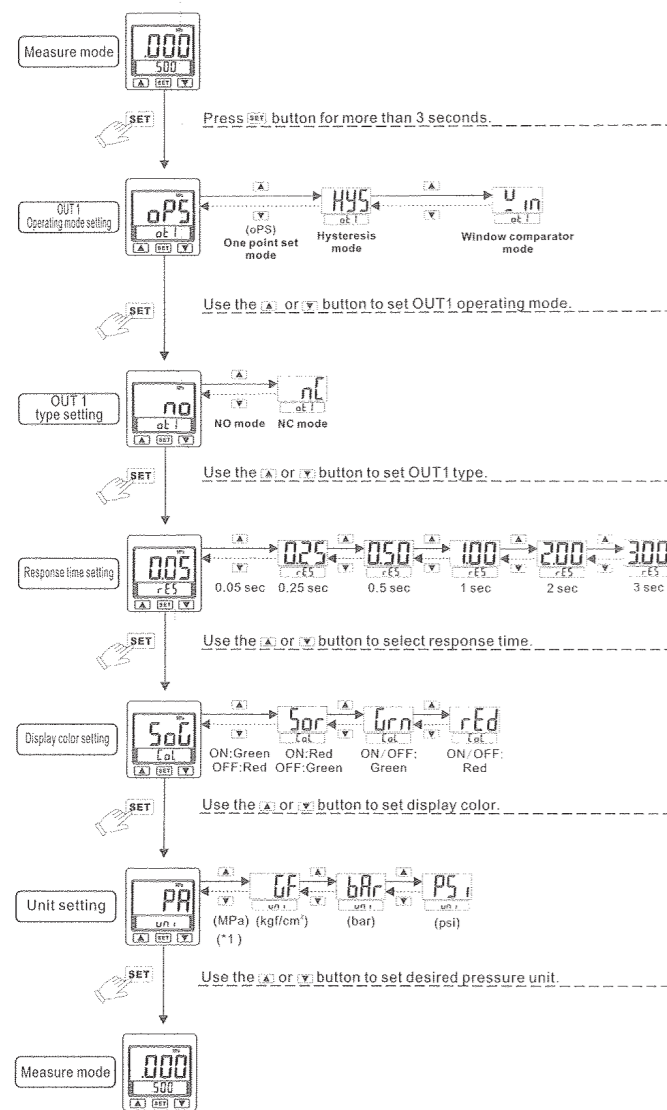

[NOTE :]
*1. Not selectable for fixed SI unit (P41P-□□-□).

H. ADVANCE SETTING MODE

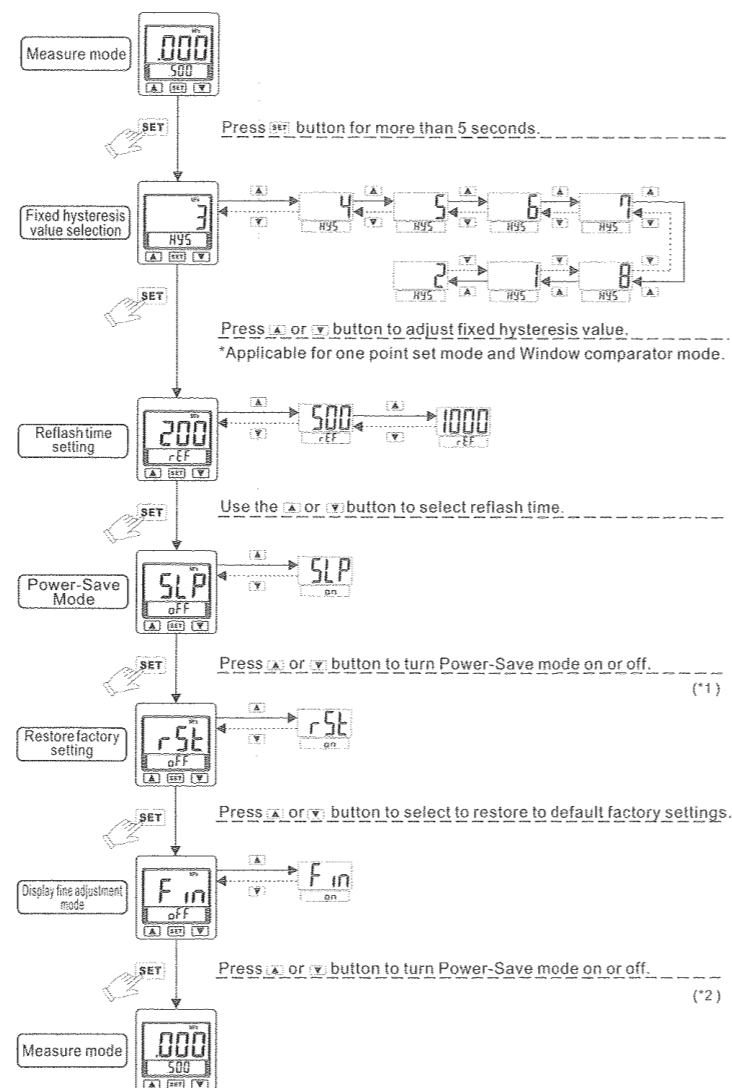

[NOTE :]
*1. When the sub-display shows "ON", Power-Save mode is activated. Please refer to Section 1 for detailed explanation.
*2. When the sub-display shows "ON", Display fine adjustment mode is activated. Please refer to Section 1 for detailed explanation.

I. POWER-SAVE MODE

- During Power-Save mode, the main display will turned off if no buttons is pressed after 30 seconds.
- During Power-Save mode, the output LCD's may not be synchronize with the output. It is normal and will not affect output operation.
- Press any button to turn-on main display temporarily.

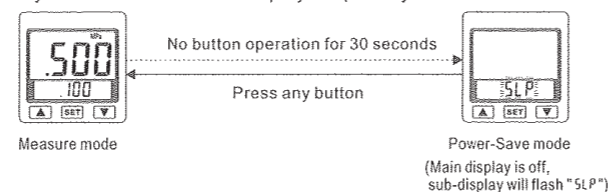

J. PRESSURE SETTING MODE

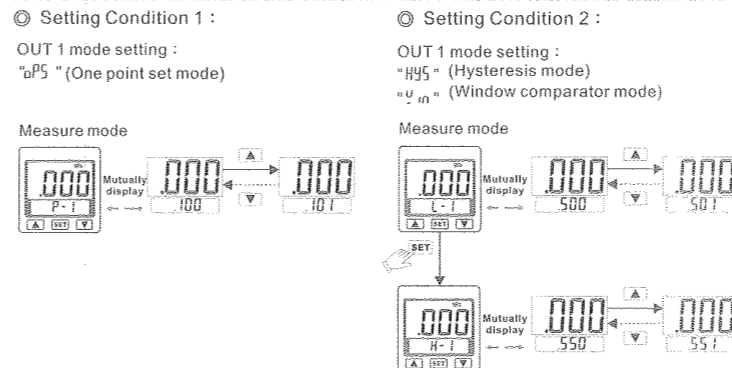

[NOTE :]
Do not disconnect power when the sub-display and setting value is flashing alternately; otherwise the system cannot store the values.

K. OUTPUT TYPE

(1) One point set mode:

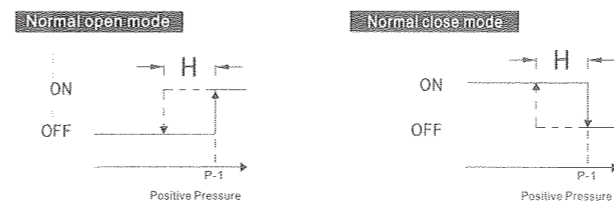

(2) Hysteresis mode:

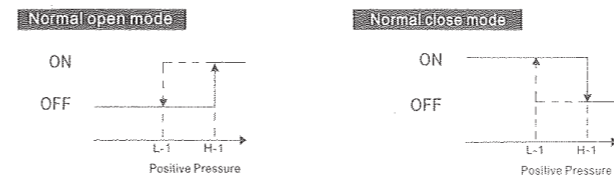

(3) Window comparator mode:

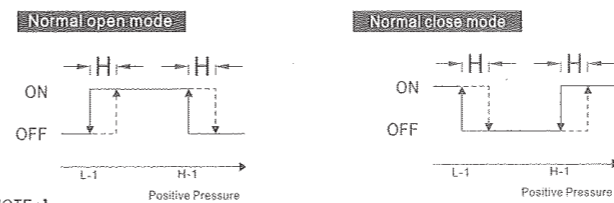

[NOTE :]
*1 In case hysteresis is set at less than or equal to 2 digits, switch output may chatter if input pressure fluctuates near the set point.
*2 When using window comparator mode, the difference between two set points must be greater than the fixed hysteresis, otherwise will cause the switch output to malfunction.

L. ZERO POINT SETTING

Press the **▲+▼** button at the same time until the "00" is shown.
Release the button to end zero setting.



M. PEAK/BOTTOM HOLD FUNCTION

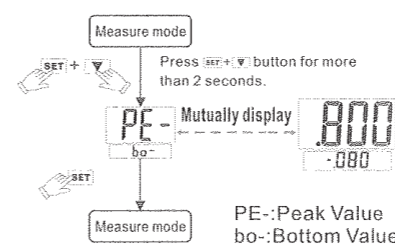

N. KEY LOCK/UNLOCK MODE

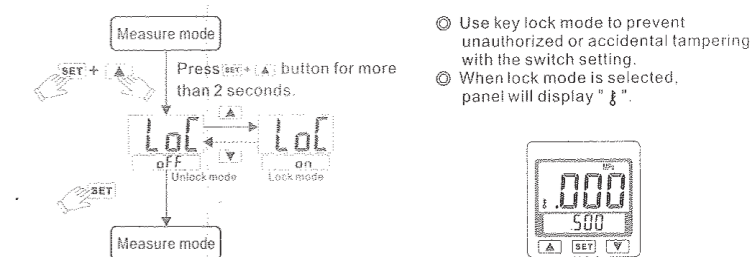

O. FINE ADJUSTMENT MODE

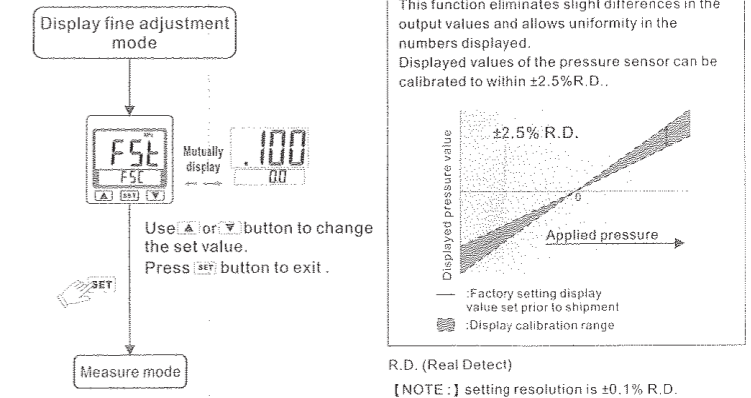

P. ERROR CODE INSTRUCTION

Error Type	Error code	Error Condition	Troubleshooting
Excess load current error	Er1	Output 1 load current is more than 125 mA	Turn power off and check the cause of overload current or lower the current load under 125 mA, then restart.
Residual pressure error	Er3	During zero reset, ambient pressure is over $\pm 3\%$ F.S.	Change input pressure to ambient pressure and perform zero reset again.
Applied pressure error	HHH	Supply pressure is exceeds the upper limit of pressure setting.	Adjust the pressure within operating pressure range.
	LLL	Supply pressure is exceeds the lower limit of pressure setting.	
System error	Er4	Internal system error	Turn power off, and then restart. If error condition remains, please return to factory for inspection.
	Er5	Internal system error	
	Er6	Internal data error	
	Er7	Internal data error	

Q. PRESSURE UNIT CONVERSION TABLE

From	To	Pa	MPa	kgf/cm ²	psi	bar
1 Pa		1	0.000001	0.00010197	0.000145038	0.00001
1 MPa		1000000	1	10.197	145.038	10
1 kgf/cm ²		98066.5	0.0980665	1	14.2233	0.980665
1 psi		6895	0.006895	0.07031	1	0.06895
1 bar		100000.0	0.100000	1.01972	14.5038	1