

valvole 16 mm ad azion. elettropneumatico

solenoid actuated valves - 16 mm



- Valvole a spola 5/2 con attacchi filettati M5 o G1/8"
5/2 spool valves with M5 or G1/8" threaded ports
- Entrata e uscite: M5 o G1/8"; scarichi: M5
Air supply and exit ports: M5 or G1/8"; exhaust ports: M5
- Elettropilota 15 mm basso assorbimento (2W) a norma DIN 43650, forma C
15 mm low consumption solenoid pilot (2W), compliant to norm DIN 43650, C form
- Azionatore manuale monostabile sull'elettropilota
Non-detented manual override on the solenoid pilot
- Sottobasi modulari (pag. 258-259) e sottobasi a posti fissi (pag. 187)
Multiple sub-bases (page 258-259) and manifolds (page 187)



I prodotti di seguito indicati sono venduti con elettropilota/i montato/i (per i dati tecnici vedi pag. 157).
The following listed products are sold with mounted solenoid pilot(s); for technical data refer to page 157.

Materiali

Corpo: alluminio 11S

Molle: INOX

Guarnizioni: NBR

Spola: alluminio nichelato

Parti interne: ottone OT58

Materials

Body: aluminium 11S

Springs: stainless steel

Seals: NBR

Spool: nickel plated aluminium

Internal parts: brass OT58

Diametro nominale <i>Nominal orifice</i>		4 mm	
Portata nominale a 6 bar, Δp 1 bar <i>Nominal flow rate at 6 bar, Δp 1 bar</i>		M5: 320 NI/min G1/8": 350 NI/min	
Temperatura di esercizio <i>Temperature range</i>		-5 ... +60°C	
Pressione di esercizio <i>Working pressure</i>	al. interna monost. [<i>monost. internal air supply</i>]	al. interna bist. [<i>bi-stable internal air supply</i>]	alim. separata [<i>separate air supply</i>]
	2.5 ... 10 bar 0.25 ... 1 MPa	2.5 ... 10 bar 0.25 ... 1 MPa	-0.9 ... 10 bar -0.09 ... 1 MPa
Pressione di azionamento (per alimentazione separata) <i>Actuating pressure (for separate air supply)</i>		monostabile [<i>mono-stable</i>]	bistabile [<i>bi-stable</i>]
		2.5 ... 10 bar 0.25 ... 1 MPa	2.5 ... 10 bar 0.25 ... 1 MPa
Fluido <i>Fluid</i>		Aria filtrata 5 μ con o senza lubrificazione <i>5μ filtered, lubricated or non lubricated air</i>	

valvole 16 mm ad azion. elettropneumatico

solenoid actuated valves - 16 mm



455 ME xx

5/2 M5 comando elettrico - ritorno a molla

5/2 M5 solenoid pilot - spring return

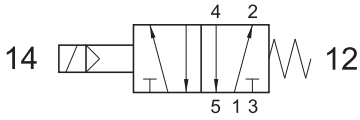

Nella sigla del prodotto sostituire le lettere "xx" con l'indicazione della tensione.
In the part number replace "xx" with the reference of the solenoid tension.

24V DC	01
24V 50/60Hz	02

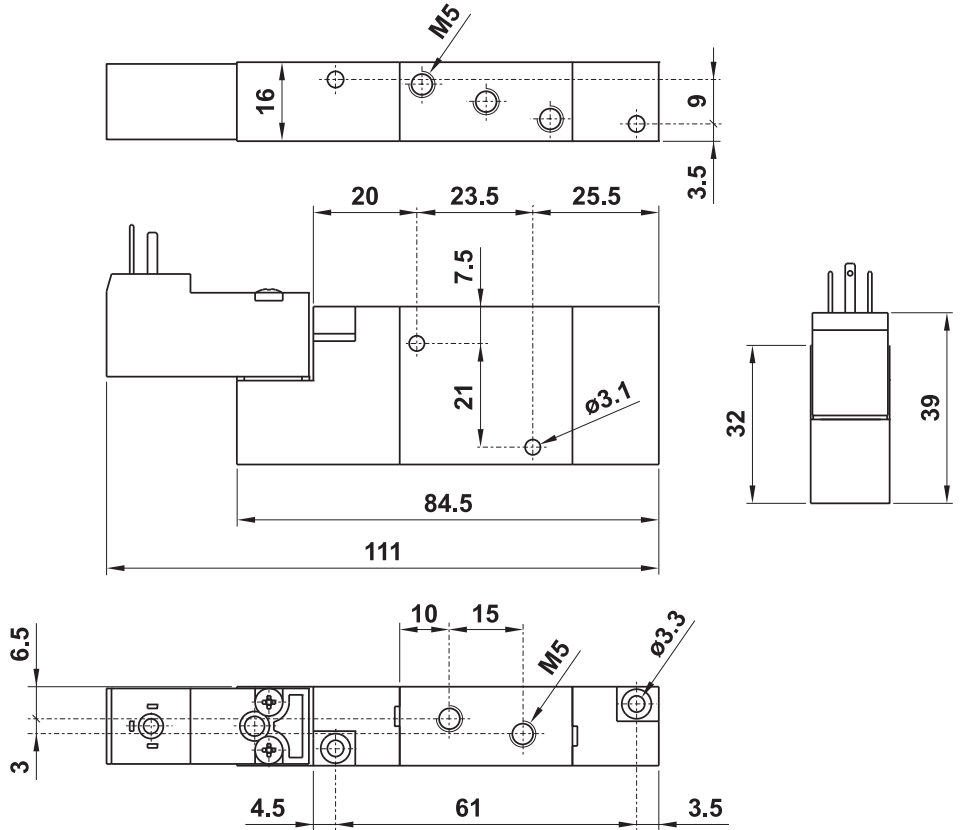

455 ME AS xx

5/2 M5 comando elettrico alimentazione separata - ritorno a molla

5/2 M5 solenoid pilot with separate air supply - spring return

L'alimentazione separata funziona solo se la valvola è montata su sottobase modulare

The separate air supply works only if the valve is mounted on modular sub-base

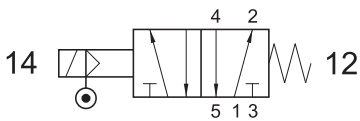

Nella sigla del prodotto sostituire le lettere "xx" con l'indicazione della tensione.
In the part number replace "xx" with the reference of the solenoid tension.

24V DC	01
24V 50/60Hz	02

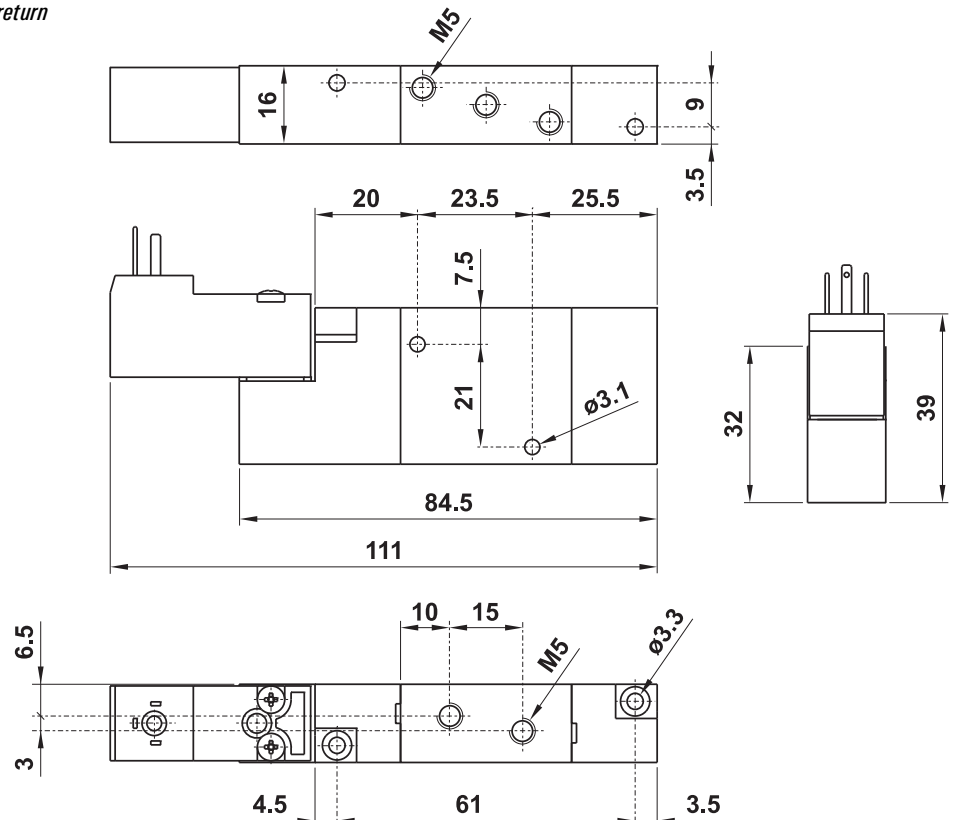

valvole 16 mm ad azion. elettropneumatico

solenoid actuated valves - 16 mm



455 CE xx

5/2 M5 comando elettrico - ritorno a comando pneumatico

5/2 M5 solenoid pilot - separate pneumatically piloted return

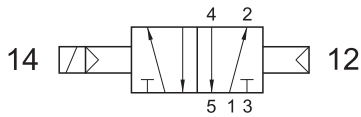

Nella sigla del prodotto sostituire le lettere "xx" con l'indicazione della tensione.
In the part number replace "xx" with the reference of the solenoid tension.

24V DC	01
24V 50/60Hz	02

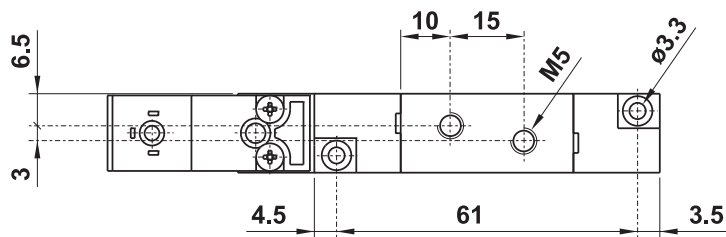
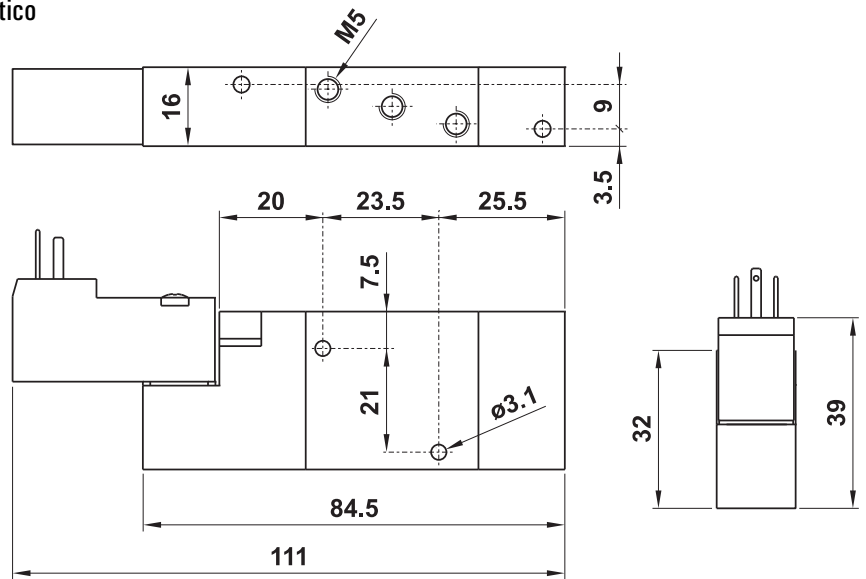

valvole 16 mm ad azion. elettropneumatico

solenoid actuated valves - 16 mm



455 EE xx

5/2 M5 doppio comando elettrico

5/2 M5 double solenoid pilot

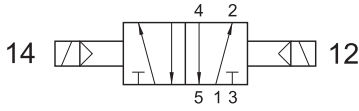

Nella sigla del prodotto sostituire le lettere "xx" con l'indicazione della tensione.
In the part number replace "xx" with the reference of the solenoid tension.

24V DC	01
24V 50/60Hz	02

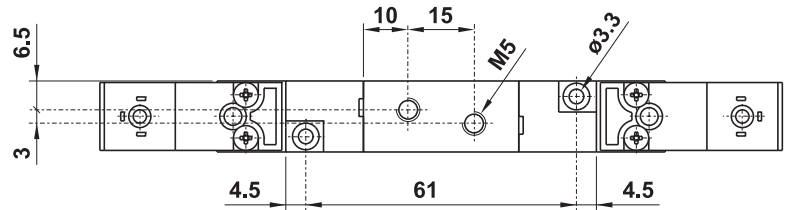
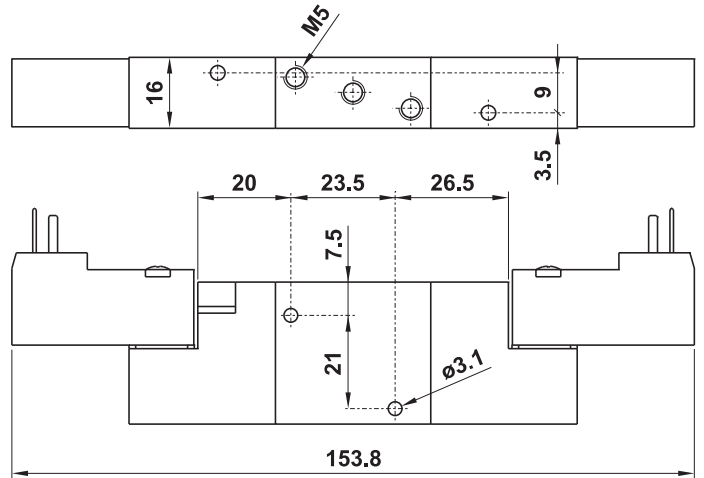
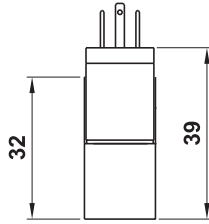

455 EE AS xx

5/2 M5 doppio comando elettrico alimentazione separata

5/2 M5 double solenoid pilot with separate air supply

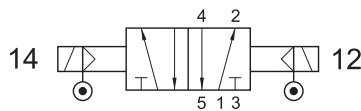

Nella sigla del prodotto sostituire le lettere "xx" con l'indicazione della tensione.
In the part number replace "xx" with the reference of the solenoid tension.

24V DC	01
24V 50/60Hz	02

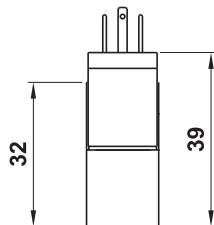

L'alimentazione separata funziona solo se la valvola è montata su sottobase modulare

The separate air supply works only if the valve is mounted on modular sub-base

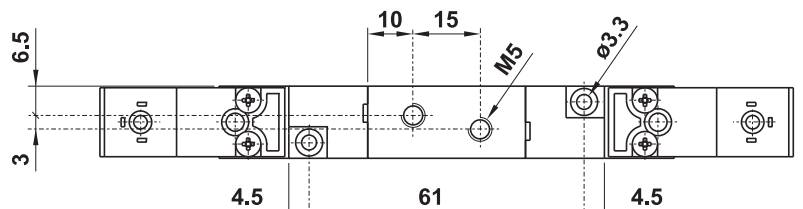
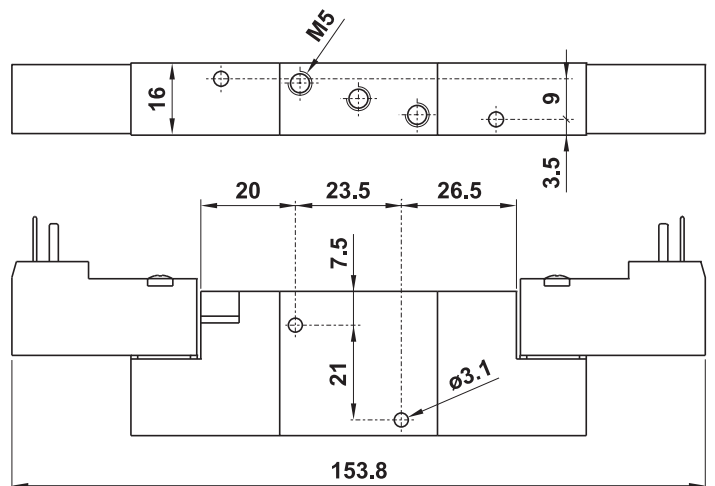

valvole 16 mm ad azion. elettropneumatico

solenoid actuated valves - 16 mm



451 ME xx

5/2 1/8" comando elettrico - ritorno a molla

5/2 1/8" solenoid pilot - spring return

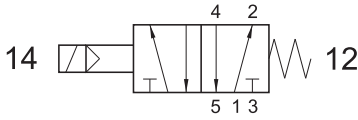

Nella sigla del prodotto sostituire le lettere "xx" con l'indicazione della tensione.
In the part number replace "xx" with the reference of the solenoid tension.

24V DC 01
24V 50/60Hz 02

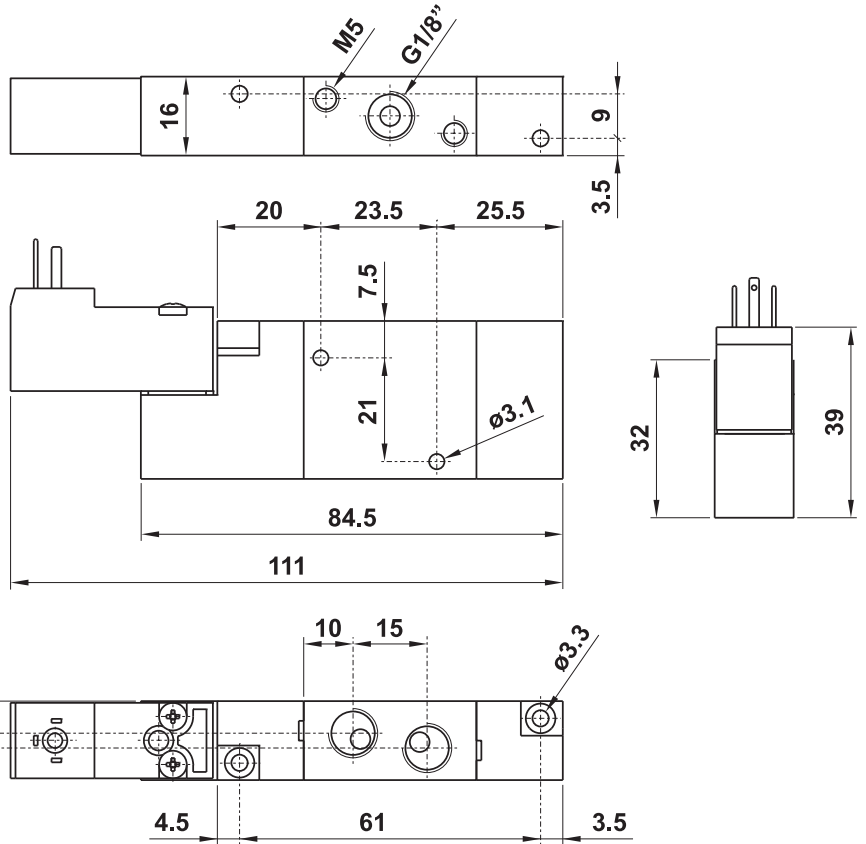

451 ME AS xx

5/2 1/8" comando elettrico alimentazione separata - ritorno a molla

5/2 1/8" solenoid pilot with separate air supply - spring return

L'alimentazione separata funziona solo se la valvola è montata su sottobase modulare

The separate air supply works only if the valve is mounted on modular sub-base

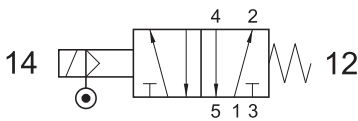

Nella sigla del prodotto sostituire le lettere "xx" con l'indicazione della tensione.
In the part number replace "xx" with the reference of the solenoid tension.

24V DC 01
24V 50/60Hz 02

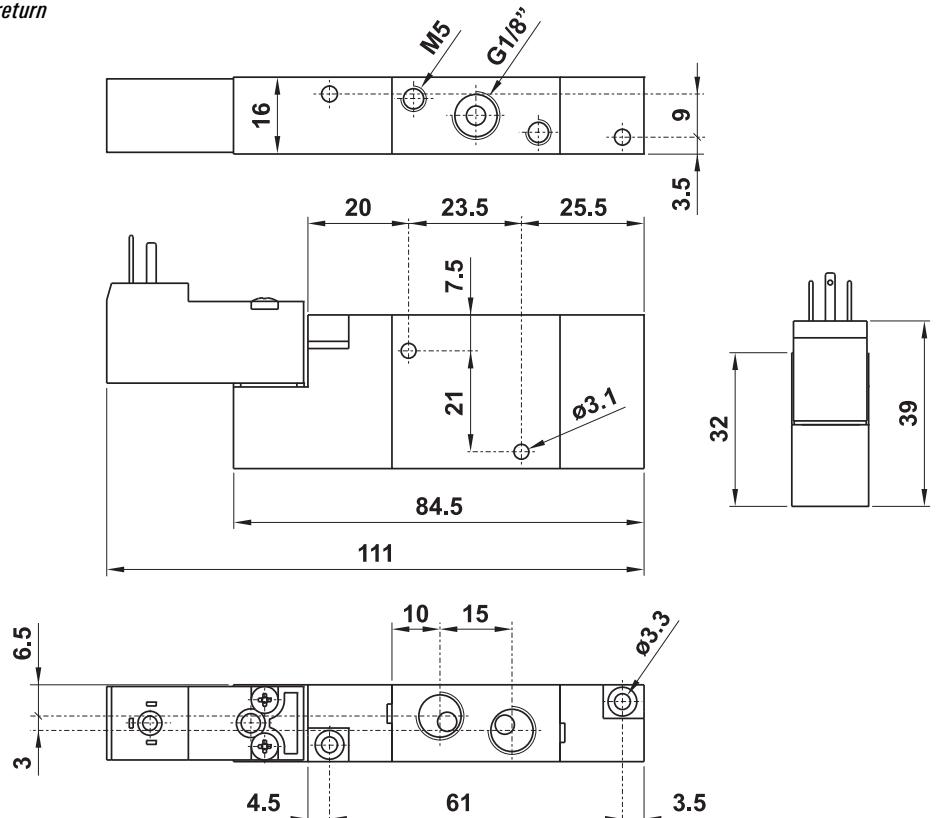

valvole 16 mm ad azion. elettropneumatico

solenoid actuated valves - 16 mm



451 CE xx

5/2 1/8" comando elettrico - ritorno a comando pneumatico

5/2 1/8" solenoid pilot - separate pneumatically piloted return

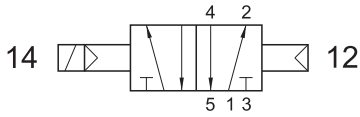

Nella sigla del prodotto sostituire le lettere "xx" con l'indicazione della tensione.
In the part number replace "xx" with the reference of the solenoid tension.

24V DC	01
24V 50/60Hz	02

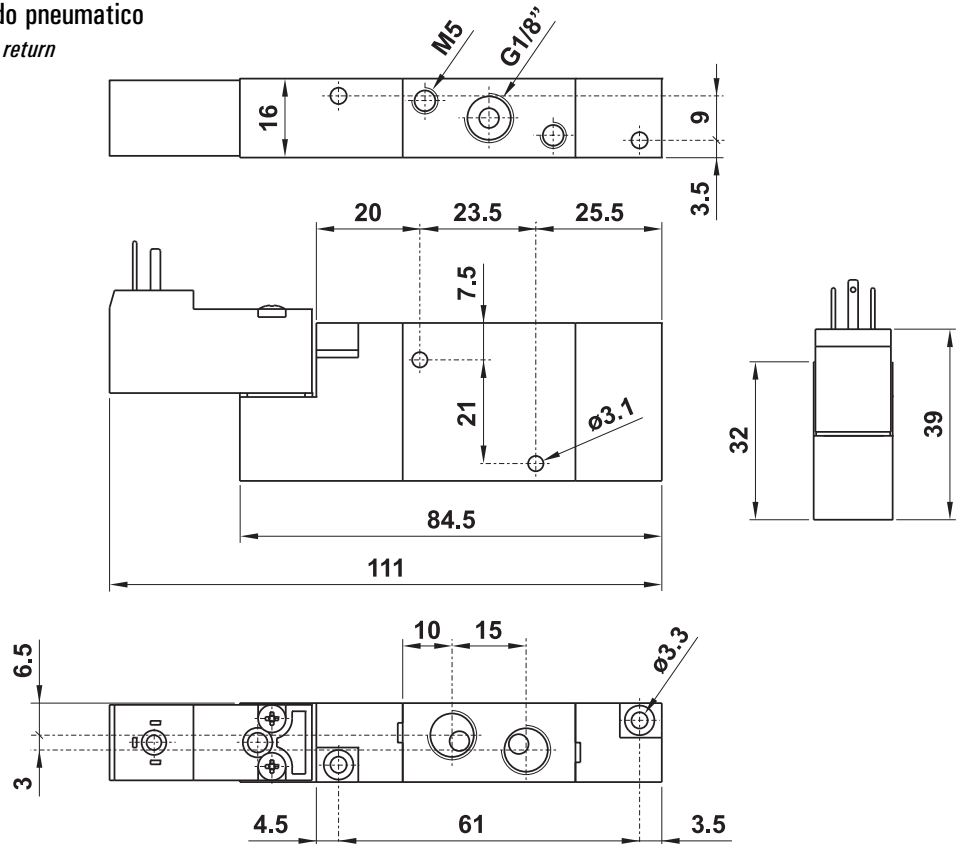

1

valvole 16 mm ad azion. elettropneumatico

solenoid actuated valves - 16 mm



451 EE xx

5/2 1/8" doppio comando elettrico

5/2 1/8" double solenoid pilot

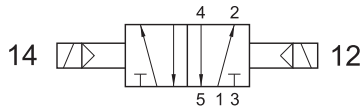

Nella sigla del prodotto sostituire le lettere "xx" con l'indicazione della tensione.
In the part number replace "xx" with the reference of the solenoid tension.

24V DC	01
24V 50/60Hz	02

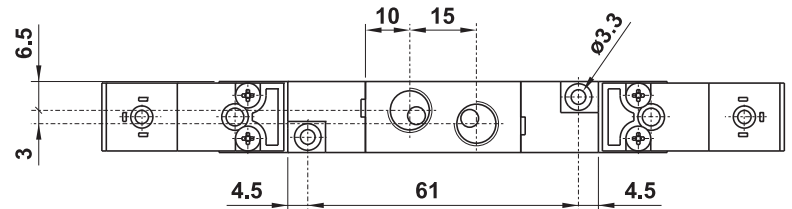
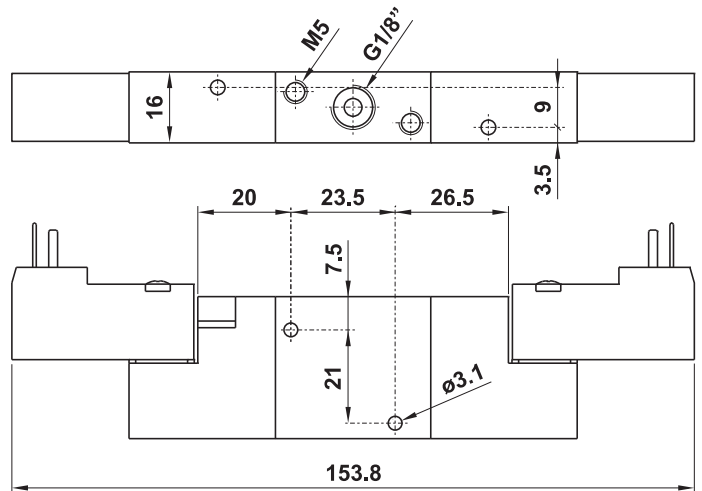
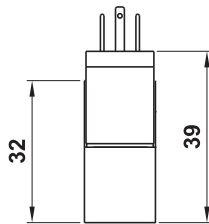

451 EE AS xx

5/2 1/8" doppio comando elettrico alimentazione separata

5/2 1/8" double solenoid pilot with separate air supply

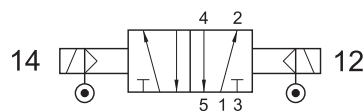

Nella sigla del prodotto sostituire le lettere "xx" con l'indicazione della tensione.
In the part number replace "xx" with the reference of the solenoid tension.

24V DC	01
24V 50/60Hz	02

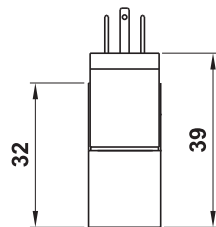

L'alimentazione separata funziona solo se la valvola è montata su sottobase modulare

The separate air supply works only if the valve is mounted on modular sub-base

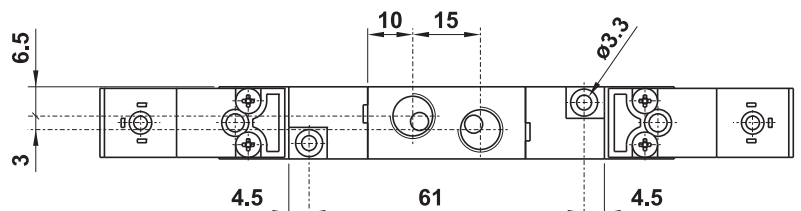
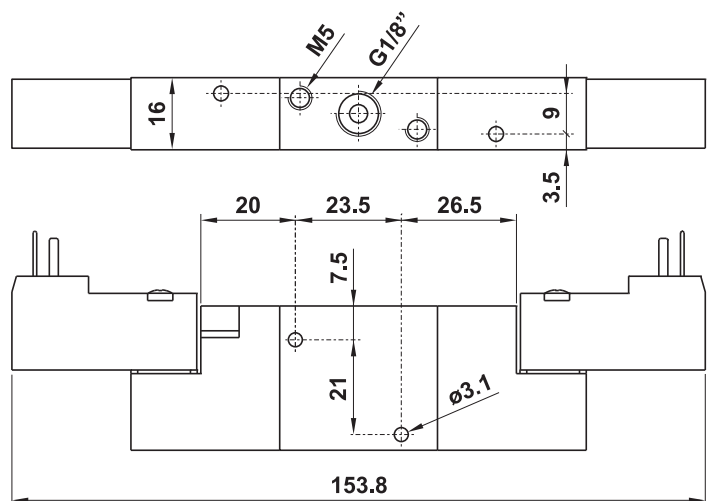

sottobasi per elettrovalvole 16 mm

manifolds for 16 mm solenoid valves



- Scarichi convogliati
Common exhaust
- Materiale: alluminio anodizzato
Material: aluminium (anodize treatment)
- Non utilizzabili per valvole alimentazione separata
Not suitable for valves with separate air supply
- Sottobasi speciali a richiesta
Special manifolds on request

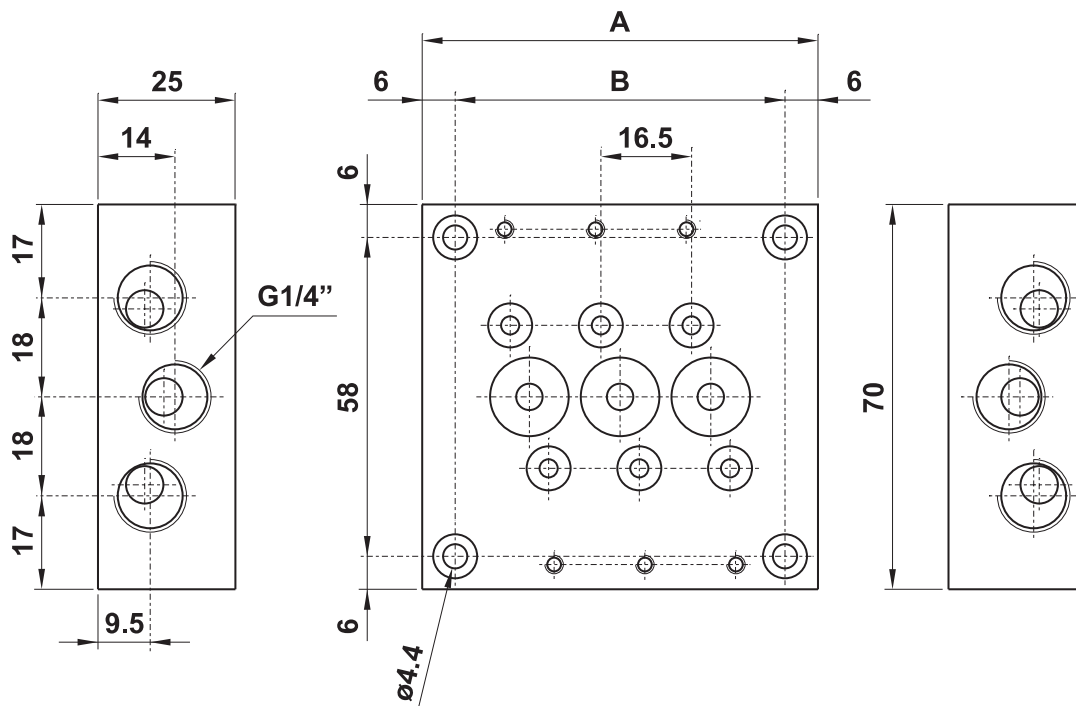
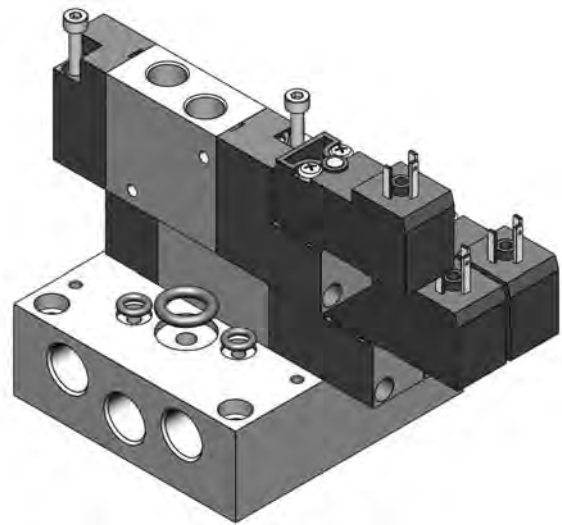

modello model	nr. posiz. no. stations	A	B
05.082.2	2	55.5	43.5
05.083.2	3	72	60
05.084.2	4	88.5	76.5
05.085.2	5	105	93
05.086.2	6	121.5	109.5
05.087.2	7	138	126
05.088.2	8	154.5	142.5
05.089.2	9	171	159
05.090.2	10	187.5	175.5
05.091.2	11	204	192
05.092.2	12	220.5	208.5

valvola 630 ME AS e sottobasi

valve 630 ME AS and sub-bases



- Valvola 3/2 a atturatore a comando elettrico, con attacchi in base
3/2 poppet valve, solenoid actuated, with connections on sub-base
- Comandi elettrici con azionamento manuale
Solenoid pilots with manual override
- Protezione elettrica IP 40
Electrical protection IP 40
- Potenza 0.5 ... 1W; tensione 24V DC
Power 0.5 ... 1W; tension 24V DC
- Entrata e scarichi: G1/8"; uscite: M5
Air supply and exhaust ports: G1/8"; exit port: M5

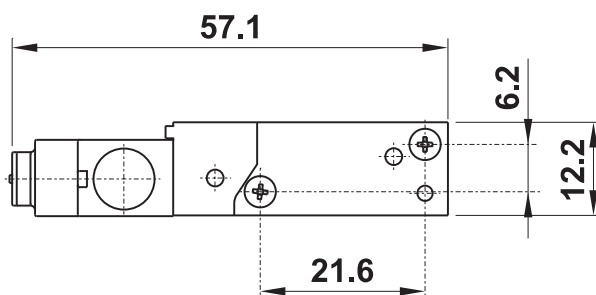
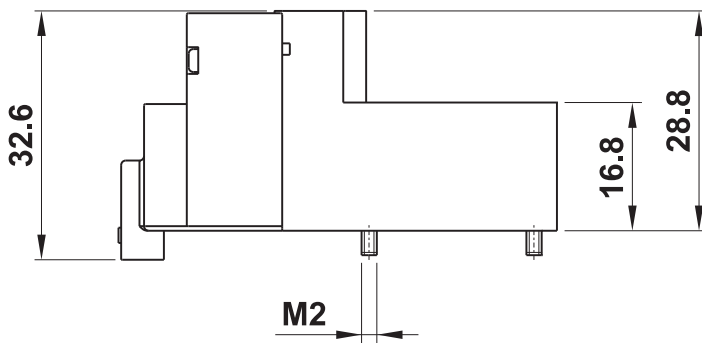
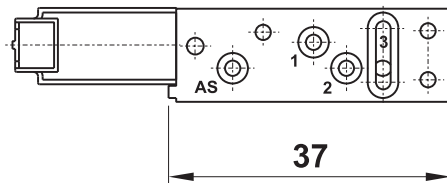
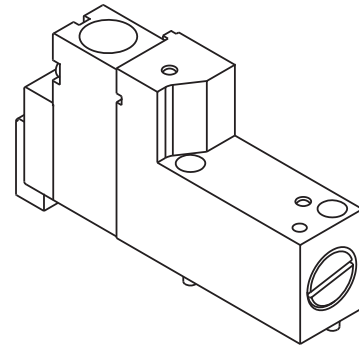

CODICE DI ORDINAZIONE
ORDER CODE

630 ME AS
05.254.4

Materiali

Corpo: alluminio 11S

Molla: INOX

Guarnizioni: NBR

Parti interne: ottone OT58

Materials

Body: aluminium 11S

Spring: stainless steel

Seals: NBR

Internal parts: brass OT58

Diametro nominale <i>Nominal orifice</i>	2 mm
Portata nominale a 6 bar, Δp 1 bar <i>Nominal flow rate at 6 bar, Δp 1 bar</i>	100 NI/min
Temperatura di esercizio <i>Temperature range</i>	-5 ... +60°C
Pressione di esercizio <i>Working pressure</i>	-0.9 ... 10 bar -0.09 ... 1 MPa
Pressione di azionamento (per alimentazione separata) <i>Actuating pressure (for separate air supply)</i>	6 ... 7 bar 0.6 ... 0.7 MPa
Fluido <i>Fluid</i>	Aria filtrata 5 μ con o senza lubrificazione <i>5μ filtered, lubricated or non lubricated air</i>

valvola 630 ME AS e sottobasi

valve 630 ME AS and sub-bases

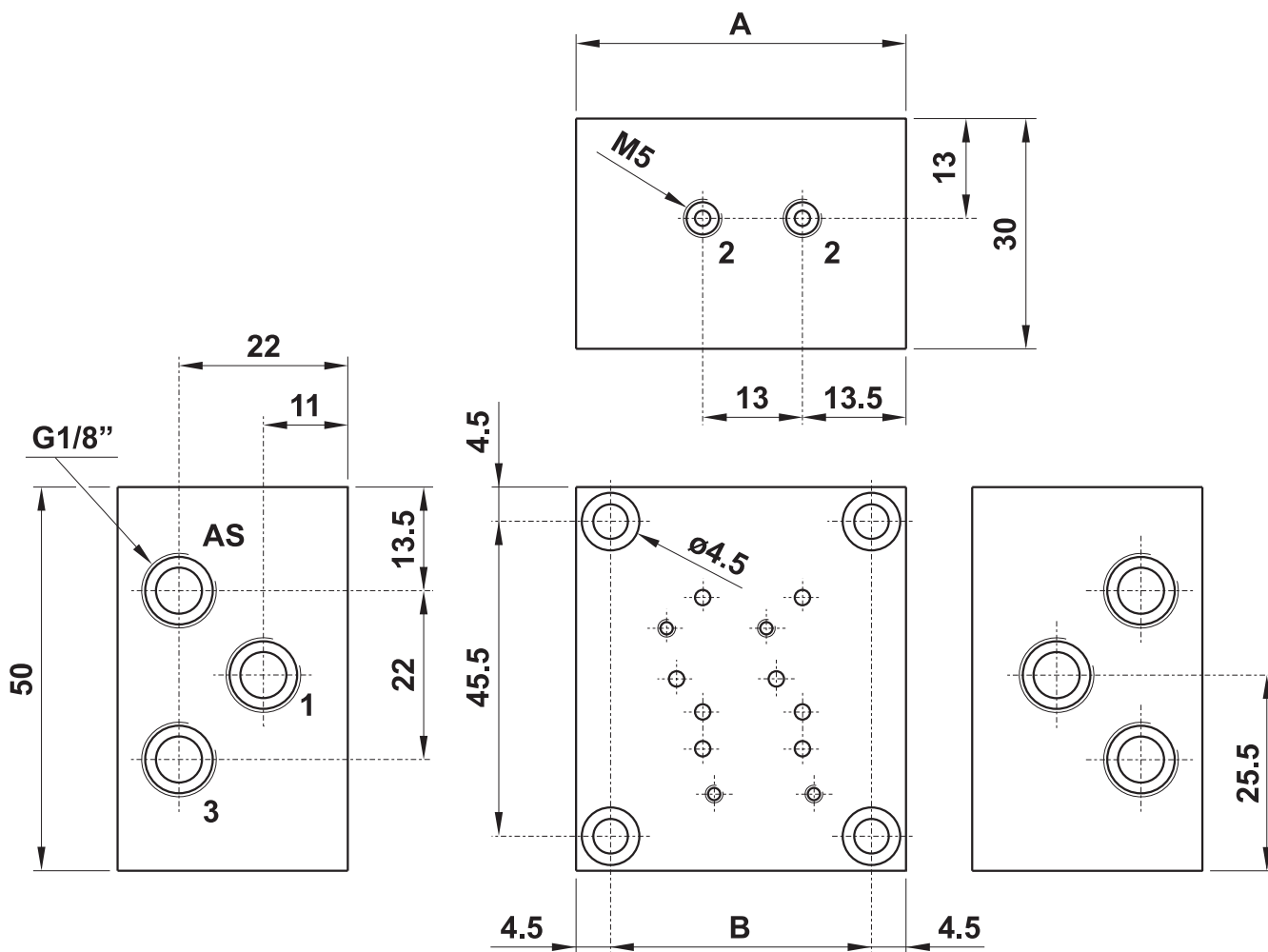

modello model	nr. posiz. no. stations	A	B
05.200.1	1	30	21
05.201.1	2	43	34
05.202.1	4	69	60
05.203.1	6	95	86
05.204.1	8	121	112