



oz pneumatica

*megbízhatóság
modern technológia
minőség*

SZÁLLÍTÁSI PROGRAM



A CÉG

AZ pneumatica

AZ Pneumatica s.r.l.

Via Kennedy, 26
20020 MISINTO (MI)
Olaszország

Tel. +39-0296328519
Fax +39-0296720095

<http://www.azpneumatica.com>
azpneu@tin.it



Az AZ Pneumatica cég 1982-től gyárt saját tervezésű pneumatika szelepeket, hengereket és más pneumatikus egységeket. Saját gyáregységünkben tíz automata, számítógép vezérlésű ipari szerszámgep biztosítja a termelékenységet, a rugalmasságot és a pontosságot.

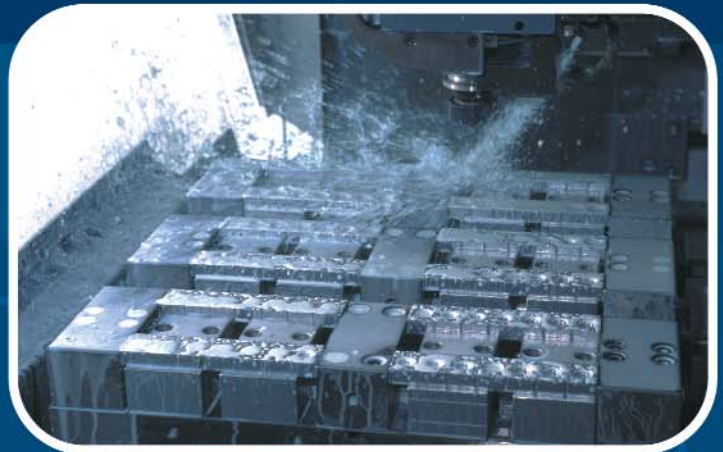

A gyártásfolyamat végén a termékek ellenőrzése teljes mértékű. Cégünk kereskedelmi hálózata folyamatosan terjeszkedik Európában és az egész világon.

Az AZ Pneumatica teljes megoldást kínál pneumatikus problémáira.

MECHANIKUS MŰKÖDTETÉSŰ SZELEPEK





ø4
304 MA
 M5
305 MA





ø4
304 MR
 M5
305 MR





ø4
304 MS
 M5
305 MS

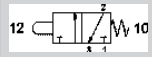

ø4
304 MV
 M5
305 MV

G1/8"
321 MP



521 MP



G1/8"
321 MPS



521 MPS



G1/8"
321 MR



521 MR



G1/8"
321 MRU



521 MRU



G1/8"
321 MRS



521 MRS





G1/8"
321 MN

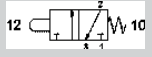

521 MN

G1/8"
431 MP

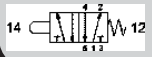

451 MP



G1/8"
431 MR



451 MR





G1/8"
431 MRL



451 MRL

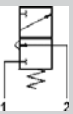

KÉZI MŰKÖDTETÉSŰ SZELEPEK

ø4
304 MB
 M5
305 MB





ø4
304 MGG
304 MGR
304 MGV
304 MGN





G1/8"
431 MGG
431 MGR
431 MGV
431 MGN

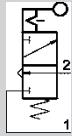

G1/8"
451 MGG
451 MGR
451 MGV
451 MGN

M5
305 LL

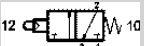
G1/8"
321 MB
521 MB



G1/8"
321 MB90
521 MB90





RM 010
RM 050 R
RM 300 N





G1/4"
PED 502 M
PED 502 B



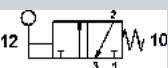

ø4
PED 304 M

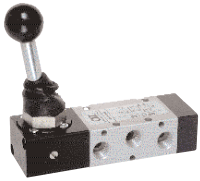
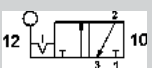
G1/8"
321 ML90
 G1/4"
322 ML90
521 ML90
 G1/4"
522 ML90

G1/8"
321 LL90
 G1/4"
322 LL90
521 LL90
 G1/4"
522 LL90

G1/8"
5213C LL90
5213A LL90
5213P LL90
 G1/4"
5223C LL90
5223A LL90
5223P LL90

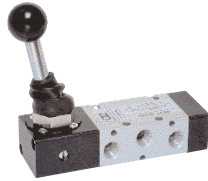
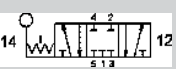

G1/8"
5213C ML90
5213A ML90
5213P ML90
 G1/4"
5223C ML90
5223A ML90
5223P ML90

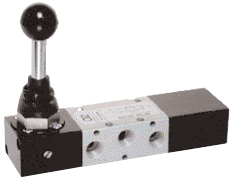
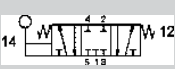

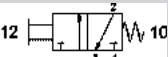
G1/8"
321 MT
 G1/4"
322 MT
521 MT
 G1/4"
522 MT

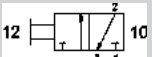
G1/8"
321 TT
 G1/4"
322 TT
521 TT
 G1/4"
522 TT





G1/8"
321 LL
 G1/4"
322 LL
521 LL
 G1/4"
522 LL



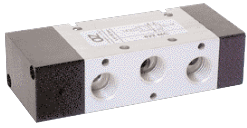

G1/8"
5213A ML

PNEUMATIKUS VEZÉRLÉSŰ SZELEPEK

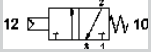

G1/8"
321 MC
G1/4"
322 MC



G1/8"
521 MC
G1/4"
522 MC



G1/8"
321 CC
G1/4"
322 CC

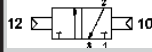

G1/8"
521 CC
G1/4"
522 CC



G1/8"
5213C CC
5213A CC
5213P CC



G1/4"
5223C CC
5223A CC
5223P CC

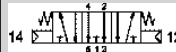

ISO 1



152 MC

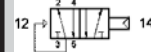

152 CFP

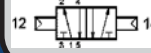

152 CC



ISO 1



153C CC
153A CC
153P CC

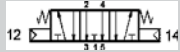

NAMUR

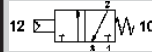

382 MC



582 MC



NAMUR

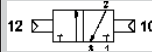

382 CC



582 CC



VDMA 18 mm



851 MC

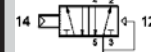

851 CFP



851 CC



VDMA
18 mm

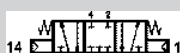

8513C CC
8513A CC

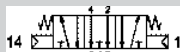

18 mm széles
G1/8"

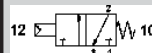

731 MC

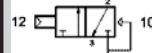

731 CFP

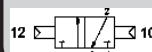

731 CC



18 mm széles
G1/8"

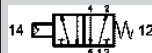

751 MC

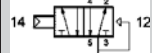

751 CFP



751 CC



G1/2"

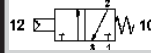

324 MC

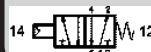

524 MC



ELEKTROMOS VEZÉRLÉSŰ SZELEPEK

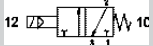
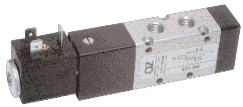

G1/8"
321 ME
G1/4"
322 ME

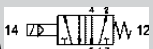

G1/8"
521 ME
G1/4"
522 ME

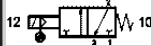
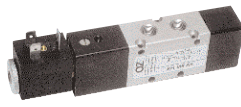

G1/8"
321 ME AS
G1/4"
322 ME AS

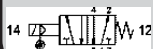

G1/8"
521 ME AS
G1/4"
522 ME AS

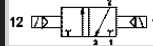

G1/8"
321 EE
G1/4"
322 EE

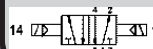

G1/8"
521 EE
G1/4"
522 EE

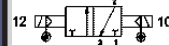
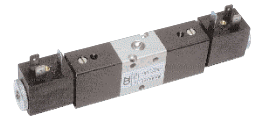

G1/8"
321 EE AS
G1/4"
322 EE AS



G1/8"
521 EE AS
G1/4"
522 EE AS

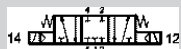

G1/8"
5213C EE
5213A EE
5213P EE



G1/4"
5223C EE
5223A EE
5223P EE



G1/8"
5213C EE AS
5213A EE AS
5213P EE AS



G1/4"
5223C EE AS
5223A EE AS
5223P EE AS

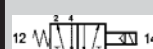
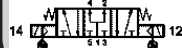

ISO 1
152 ME

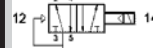

152 EFP

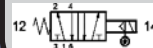

152 ME AS

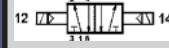

ISO 1
152 EE

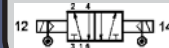

152 EE AS



ISO 1

153C EE
153A EE
153P EE

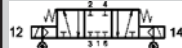
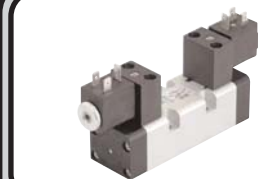
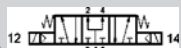
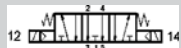

ISO 1

153C EE AS
153A EE AS
153P EE AS

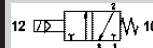
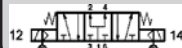

NAMUR

382 ME

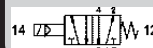

582 ME

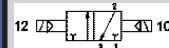

NAMUR

382 EE

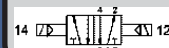

582 EE

ELEKTROMOS VEZÉRLÉSŰ SZELEPEK



VDMA 18 mm

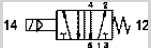

851 ME

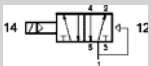

851 EFP



851 ME AS



VDMA 18 mm



851 EE

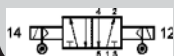

851 EE AS



VDMA
18 mm

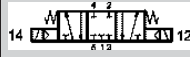

8513C EE
8513A EE

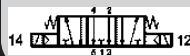

VDMA
18 mm



8513C EE AS
8513A EE AS



18 mm széles
G1/8"



751 ME

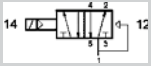

751 EFP

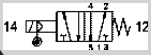

751 ME AS



18 mm széles
G1/8"



751 EE



751 EE AS



18 mm széles
G1/8"



7513C EE
7513A EE

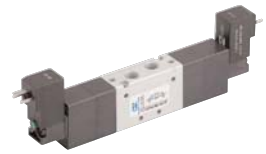
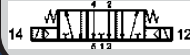

18 mm széles
G1/8"



7513C EE AS
7513A EE AS



18 mm széles
G1/8"

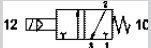

731 ME

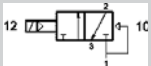

731 EFP

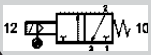

731 ME AS



18 mm széles
G1/8"

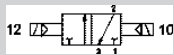

731 EE

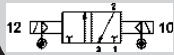

731 EE AS



G1/8"

NC: **00.051.3**
NO: **00.088.3**

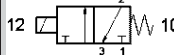

G1/4"

NC: **01.005.3**
NO: **01.066.3**

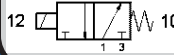

G1/2"

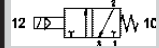

324 ME

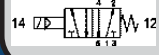

524 ME



KIEGÉSZÍTŐK



VAGY $\varnothing 4$
08.021.4
 M5
08.022.4
 G1/8"
08.023.4

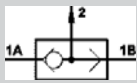

ÉS $\varnothing 4$
08.025.4
 M5
08.026.4
 G1/8"
08.027.4

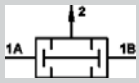

NEM
08.039.4 $\varnothing 4$

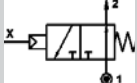

IGEN
08.049.4 $\varnothing 4$

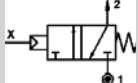

memória $\varnothing 4$
04.003.4
04.002.4

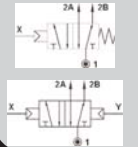

VAGY
 G1/8"
08.133.4
 G1/4"
08.127.4

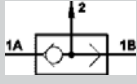

ÉS
 G1/8"
08.121.4

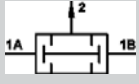

gyorsleürítő G1/8"
08.180.4
 G1/4"
08.181.4
 G1/2"
36.625.0

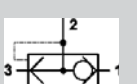

G1/8": **AZ-CRS1**
 G1/4": **AZ-CRS2**
 G3/8": **AZ-CRS3**
 G1/2": **AZ-CRS4**



nyomáskapcsoló
 G1/8"
TRP 8

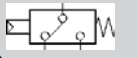

RFU M5
RFU 1/8.2
RFU 1/8.3
RFU 1/4
RFU 3/8
RFU 1/2

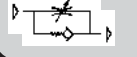

RFB M5
RFB 1/8
RFB 1/4
RFB 3/8
RFB 1/2

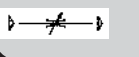

VNR M5 FF
VNR 1/8 FF
VNR 1/8 MF
VNR 1/4 FF
VNR 1/4 MF

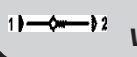

RSW 1/8
RSW 1/4
RSW 3/8
RSW 1/2



RSTC 1/8
RSTC 1/4

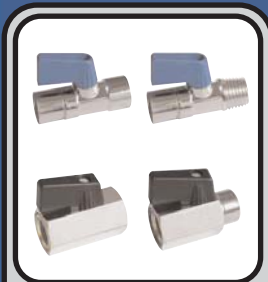

VS100
VS110
VS400
VS405



elosztók



nyomáskapcsolók



RP020



RP115



RP230



RP560



RG053



RP215



RP225



RP040



RP030



RP700



RC030



RC400



RC110



RC510



RC620



RC625



RC600



RC500



RC320



RC321



RZ120



RZ140



RZ230



RZ500



RZ330



RZ300



Rilsan PA11:
PA11A (kék)
PA11N (átlátszó)
 Poliuretán:
PU (kék)



INTEGRÁLT ELEMÉK

oszcillátor



01.044.4
01.046.4
01.008.3

flip-flop



10.018.3
10.035.4

duo-nyomású szelep



00.047.4
00.008.3

impulzus generátor



NO: 10.001.4
NC: 10.009.4

lágymű indító szelep

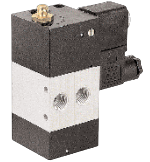

10.003.3

vákuum generátor



DP 2010 E

2 utas vákuum generátor



DP 2018 F

vákuum ejektor

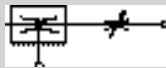

DP 2005

két-kezes indító



08.156.4

pneumatikus időzítő



00.074.4

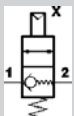

G1/8"
11.044.4

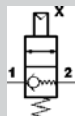

G1/4"
11.076.4

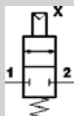

G1/8"
11.066.4

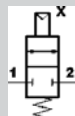

G1/4"
11.077.4

hengerek ISO 6431 VDMA



ø32 ... ø200

henger KIT ISO 6431



ø32 ... ø200

LEVEGŐELŐKÉSZÍTŐ EGYSÉGEK



szűrők



G1/4" **FIL 2-25-S**
 G3/8" **FIL 3-30-S**
 G1/2" **FIL 4-30-S**
 G1" **FIL 6-30-S**

nyomásszabályozók



G1/4" **REG 2-08**
 G3/8" **REG 3-08**
 G1/2" **REG 4-08**
 G1" **REG 6-10**

olajozók



G1/4" **LUB 2-00**
 G3/8" **LUB 3-00**
 G1/2" **LUB 4-00**
 G1" **LUB 6-00**

szűrő-nyomásszabályozók



G1/4" **FR 2-08-25-S**
 G3/8" **FR 3-08-30-S**
 G1/2" **FR 4-08-30-S**
 G1" **FR 6-10-30-S**

FR+L



G1/4" **FR+L 2-08-25-S**
 G3/8" **FR+L 3-08-30-S**
 G1/2" **FR+L 4-08-30-S**
 G1" **FR+L 6-10-30-S**

FRL



G1/4" **FRL 2-08-25-S**
 G3/8" **FRL 3-08-30-S**
 G1/2" **FRL 4-08-30-S**
 G1" **FRL 6-10-30-S**

elzáró szelep

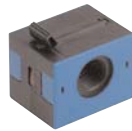

G3/8" **SR M-3**
 G1/2" **SR M-4**
 G1" **SR M-6**

gyorsleürítő



G3/8" **SCR 3-E**
 G1/2" **SCR 4-E**

lágýindító szelep



G3/8" **AVP 3-00**
 G1/2" **AVP 4-00**

proporcionális szabályozó



G3/8" **RPE 3 V NC**
RPE 3 V NA
 G1/2" **RPE 4 V NC**
RPE 4 V NA

PNEUMATIKUS MUNKAHENGEREK



minihengerek ISO 6432



ø10 ... ø25

hengerek T-széria



ø32, 40, 50

kompakt hengerek



ø32 ... ø100

rövid löketű hengerek

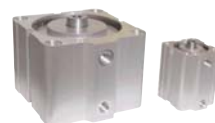

ø16 ... ø100

dugattyúrúd nélküli hengerek



ø16, 25, 32, 40, 50, 63, 80



*AZ Pneumatica s.r.l.
Via Kennedy 26
20020 MISINTO (MI)
OLASZORSZÁG*

*Tel: +39-0296328519
Fax: +39-0296720095
e-mail: azpneu@tin.it
<http://www.azpneumatica.com>*