

valvole 16 mm ad azion. elettropneumatico

solenoid actuated valves - 16 mm



- Valvole a spola 5/2 con attacchi filettati M5 o G1/8"
5/2 spool valves with M5 or G1/8" threaded ports
- Entrata e uscite: M5 o G1/8"; scarichi: M5
Air supply and exit ports: M5 or G1/8"; exhaust ports: M5
- Elettropilota 15 mm basso assorbimento (2W) a norma DIN 43650, forma C
15 mm low consumption solenoid pilot (2W), compliant to norm DIN 43650, C form
- Azionatore manuale monostabile sull'elettropilota
Non-detented manual override on the solenoid pilot
- Sottobasi modulari (pag. 258-259) e sottobasi a posti fissi (pag. 187)
Multiple sub-bases (page 258-259) and manifolds (page 187)



I prodotti di seguito indicati sono venduti con elettropilota/i montato/i (per i dati tecnici vedi pag. 157).
The following listed products are sold with mounted solenoid pilot(s); for technical data refer to page 157.

Materiali

Corpo: alluminio 11S

Molle: INOX

Guarnizioni: NBR

Spola: alluminio nichelato

Parti interne: ottone OT58

Materials

Body: aluminium 11S

Springs: stainless steel

Seals: NBR

Spool: nickel plated aluminium

Internal parts: brass OT58

Diametro nominale <i>Nominal orifice</i>		4 mm	
Portata nominale a 6 bar, Δp 1 bar <i>Nominal flow rate at 6 bar, Δp 1 bar</i>		M5: 320 NI/min G1/8": 350 NI/min	
Temperatura di esercizio <i>Temperature range</i>		-5 ... +60°C	
Pressione di esercizio <i>Working pressure</i>	al. interna monost. [<i>monost. internal air supply</i>]	al. interna bist. [<i>bi-stable internal air supply</i>]	alim. separata [<i>separate air supply</i>]
	2.5 ... 10 bar 0.25 ... 1 MPa	2.5 ... 10 bar 0.25 ... 1 MPa	-0.9 ... 10 bar -0.09 ... 1 MPa
Pressione di azionamento (per alimentazione separata) <i>Actuating pressure (for separate air supply)</i>		monostabile [<i>mono-stable</i>]	bistabile [<i>bi-stable</i>]
		2.5 ... 10 bar 0.25 ... 1 MPa	2.5 ... 10 bar 0.25 ... 1 MPa
Fluido <i>Fluid</i>		Aria filtrata 5 μ con o senza lubrificazione <i>5μ filtered, lubricated or non lubricated air</i>	

valvole 16 mm ad azion. elettropneumatico

solenoid actuated valves - 16 mm



455 ME xx

5/2 M5 comando elettrico - ritorno a molla

5/2 M5 solenoid pilot - spring return

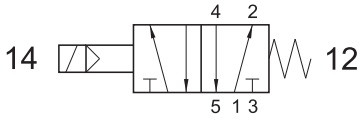

Nella sigla del prodotto sostituire le lettere "xx" con l'indicazione della tensione.
In the part number replace "xx" with the reference of the solenoid tension.

24V DC	01
24V 50/60Hz	02

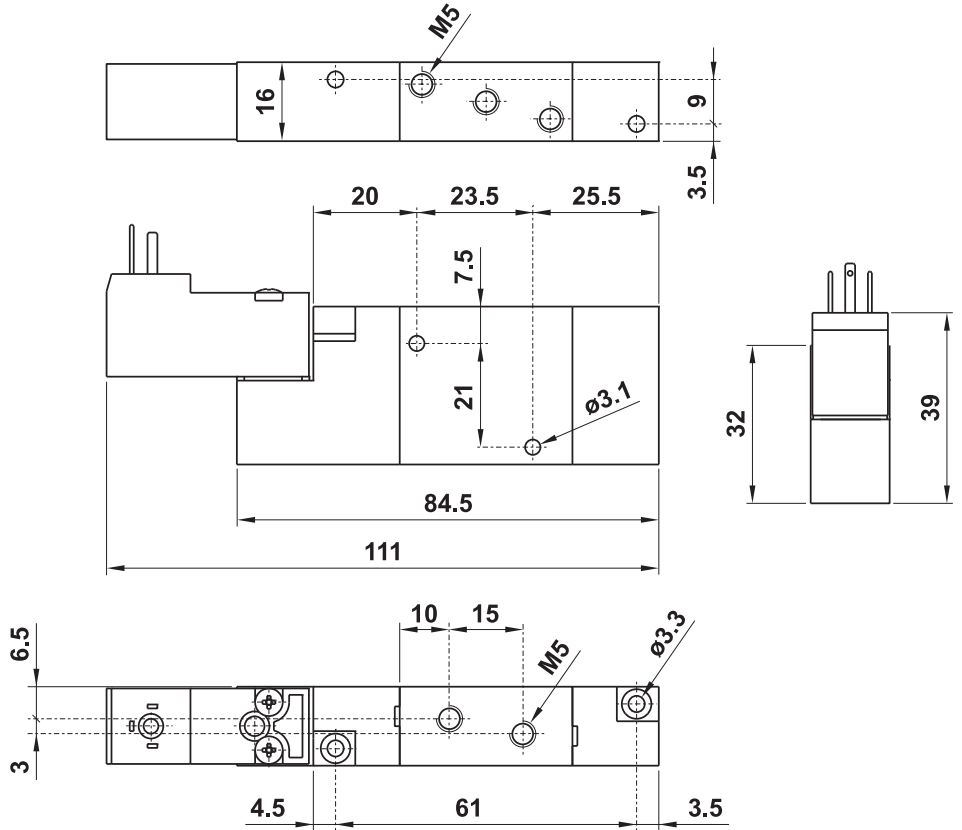

455 ME AS xx

5/2 M5 comando elettrico alimentazione separata - ritorno a molla

5/2 M5 solenoid pilot with separate air supply - spring return

L'alimentazione separata funziona solo se la valvola è montata su sottobase modulare

The separate air supply works only if the valve is mounted on modular sub-base

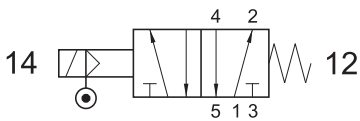

Nella sigla del prodotto sostituire le lettere "xx" con l'indicazione della tensione.
In the part number replace "xx" with the reference of the solenoid tension.

24V DC	01
24V 50/60Hz	02

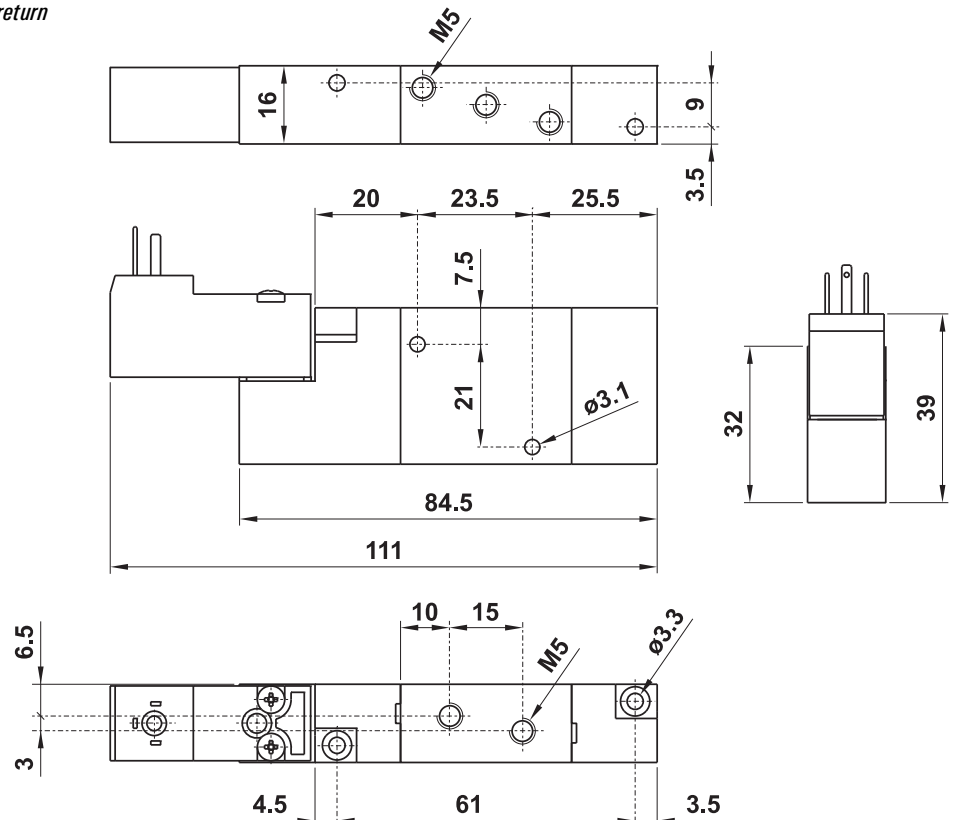

valvole 16 mm ad azion. elettropneumatico

solenoid actuated valves - 16 mm



455 CE xx

5/2 M5 comando elettrico - ritorno a comando pneumatico

5/2 M5 solenoid pilot - separate pneumatically piloted return

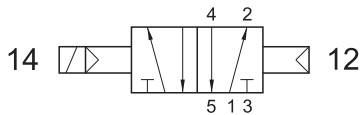

Nella sigla del prodotto sostituire le lettere "xx" con l'indicazione della tensione.
In the part number replace "xx" with the reference of the solenoid tension.

24V DC 01
24V 50/60Hz 02

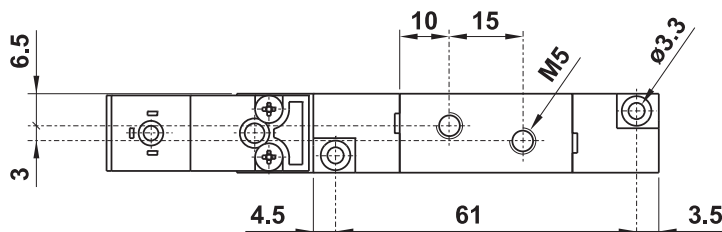
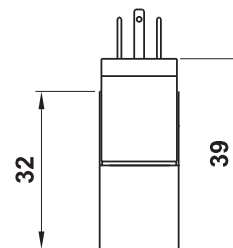
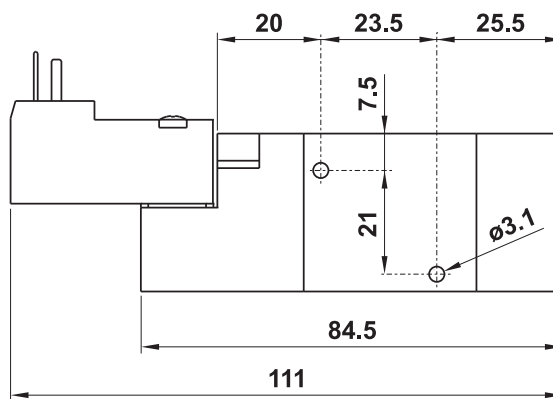
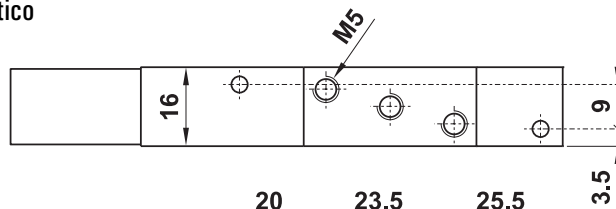

valvole 16 mm ad azion. elettropneumatico

solenoid actuated valves - 16 mm



455 EE xx

5/2 M5 doppio comando elettrico

5/2 M5 double solenoid pilot

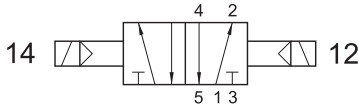

Nella sigla del prodotto sostituire le lettere "xx" con l'indicazione della tensione.
In the part number replace "xx" with the reference of the solenoid tension.

24V DC	01
24V 50/60Hz	02

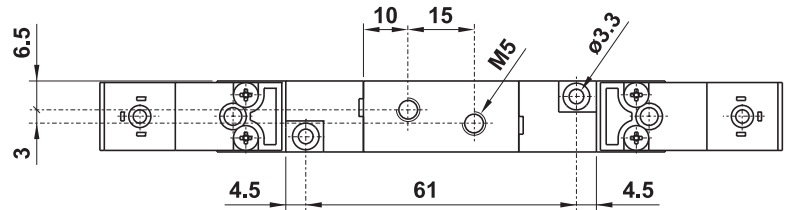
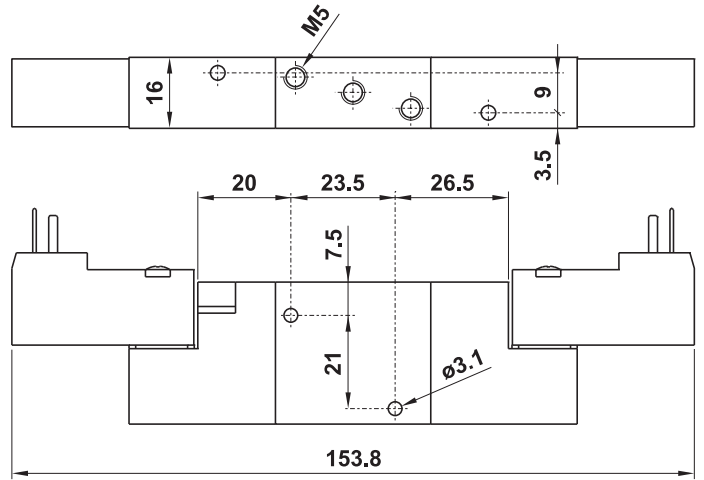
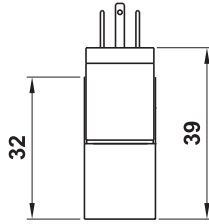

455 EE AS xx

5/2 M5 doppio comando elettrico alimentazione separata

5/2 M5 double solenoid pilot with separate air supply

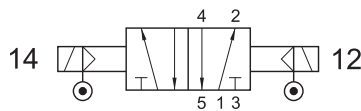

Nella sigla del prodotto sostituire le lettere "xx" con l'indicazione della tensione.
In the part number replace "xx" with the reference of the solenoid tension.

24V DC	01
24V 50/60Hz	02

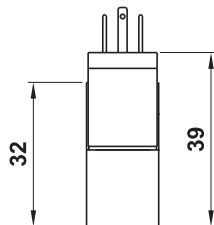

L'alimentazione separata funziona solo se la valvola è montata su sottobase modulare

The separate air supply works only if the valve is mounted on modular sub-base

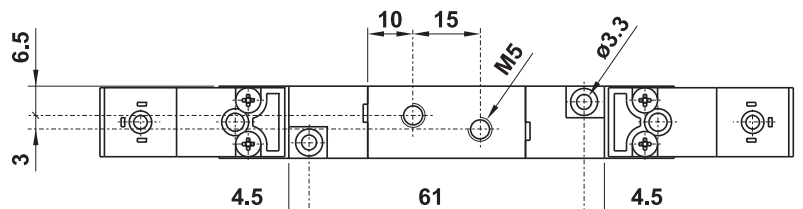
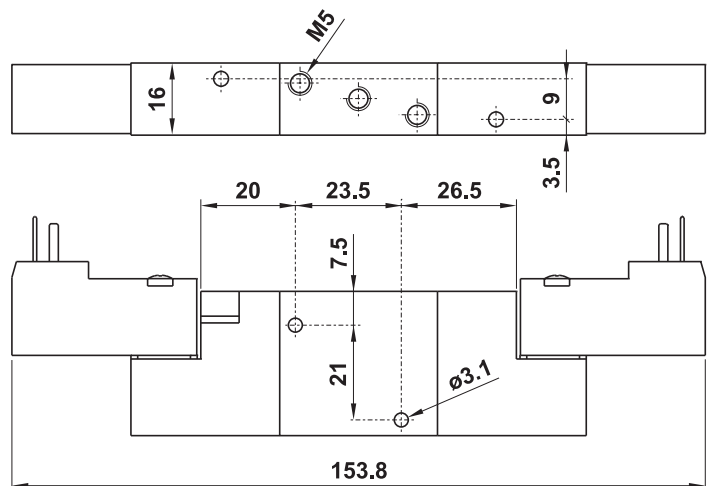

valvole 16 mm ad azion. elettropneumatico

solenoid actuated valves - 16 mm



451 ME xx

5/2 1/8" comando elettrico - ritorno a molla

5/2 1/8" solenoid pilot - spring return

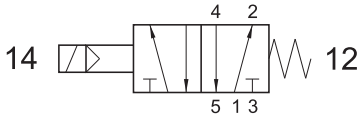

Nella sigla del prodotto sostituire le lettere "xx" con l'indicazione della tensione.
In the part number replace "xx" with the reference of the solenoid tension.

24V DC 01
24V 50/60Hz 02

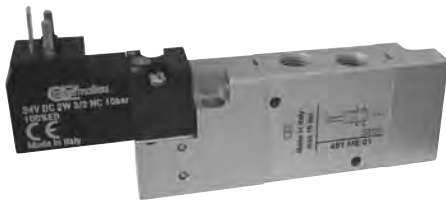
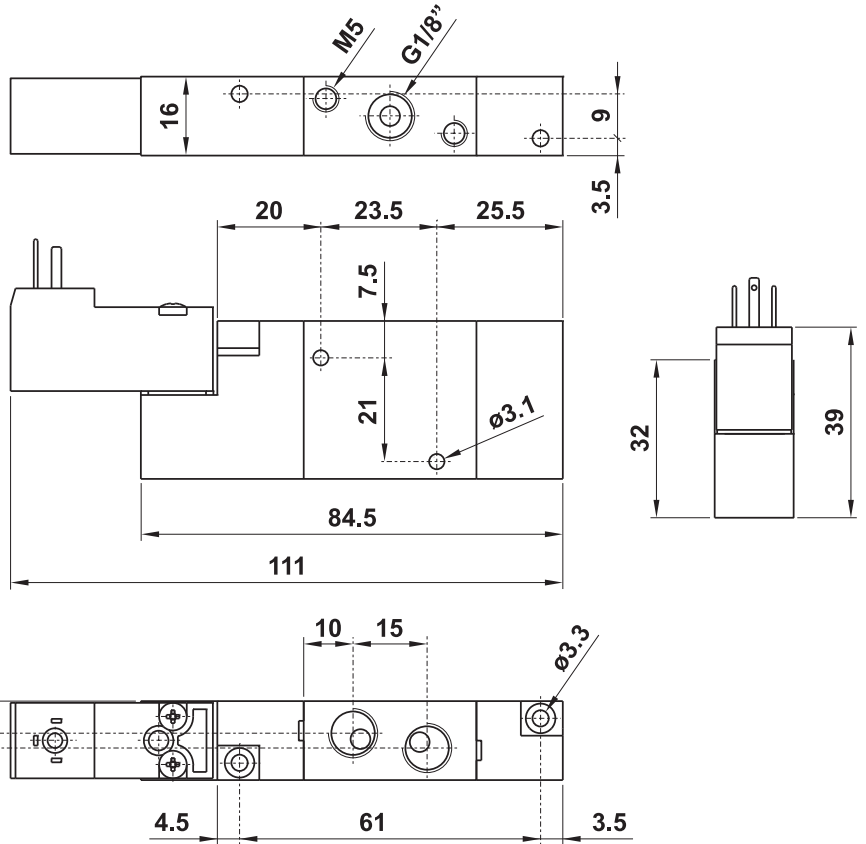

451 ME AS xx

5/2 1/8" comando elettrico alimentazione separata - ritorno a molla

5/2 1/8" solenoid pilot with separate air supply - spring return

L'alimentazione separata funziona solo se la valvola è montata su sottobase modulare

The separate air supply works only if the valve is mounted on modular sub-base

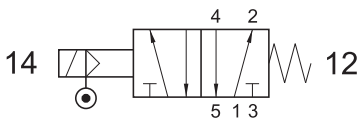

Nella sigla del prodotto sostituire le lettere "xx" con l'indicazione della tensione.
In the part number replace "xx" with the reference of the solenoid tension.

24V DC 01
24V 50/60Hz 02

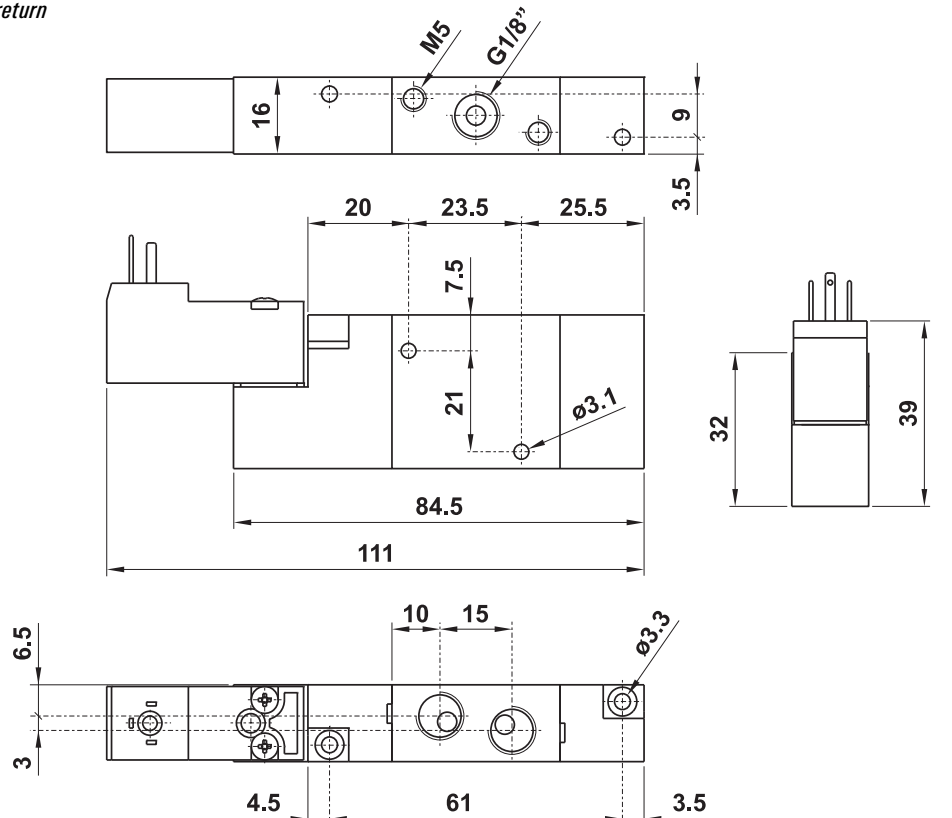

valvole 16 mm ad azion. elettropneumatico

solenoid actuated valves - 16 mm



451 CE xx

5/2 1/8" comando elettrico - ritorno a comando pneumatico

5/2 1/8" solenoid pilot - separate pneumatically piloted return

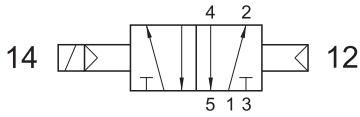

Nella sigla del prodotto sostituire le lettere "xx" con l'indicazione della tensione.
In the part number replace "xx" with the reference of the solenoid tension.

24V DC	01
24V 50/60Hz	02

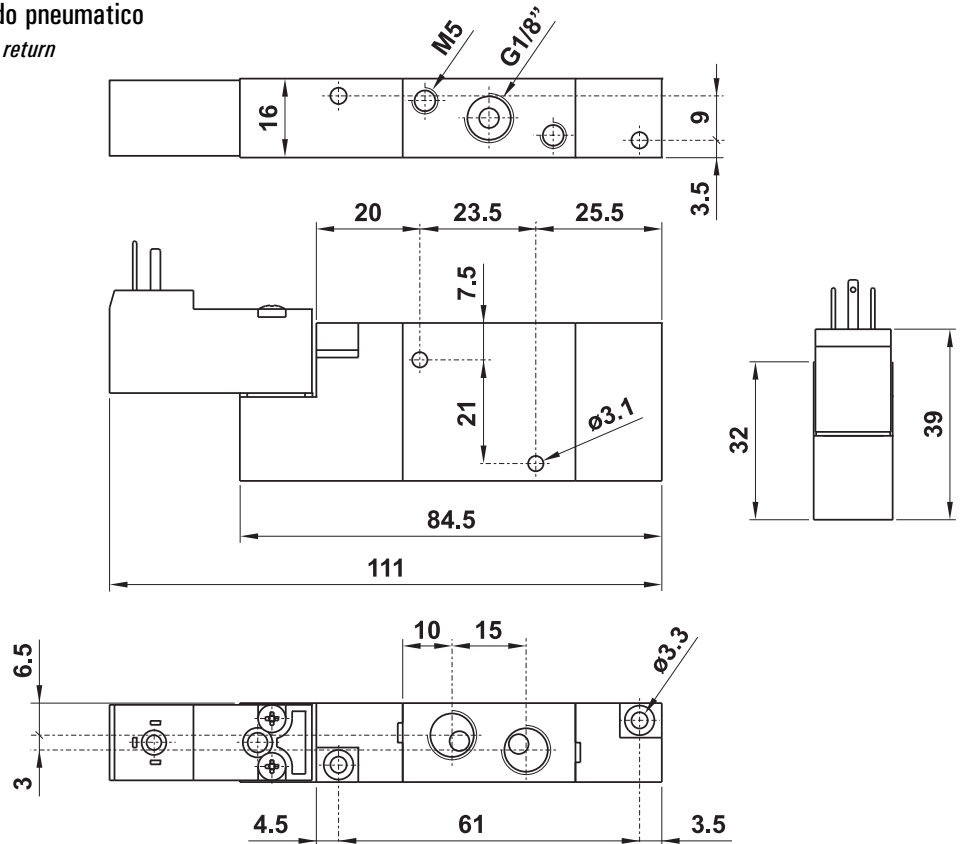

1

valvole 16 mm ad azion. elettropneumatico

solenoid actuated valves - 16 mm



451 EE xx

5/2 1/8" doppio comando elettrico

5/2 1/8" double solenoid pilot

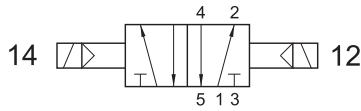

Nella sigla del prodotto sostituire le lettere "xx" con l'indicazione della tensione.
In the part number replace "xx" with the reference of the solenoid tension.

24V DC	01
24V 50/60Hz	02

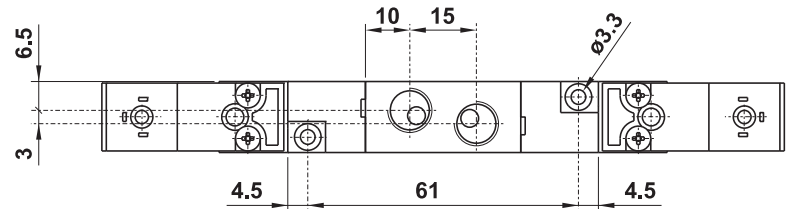
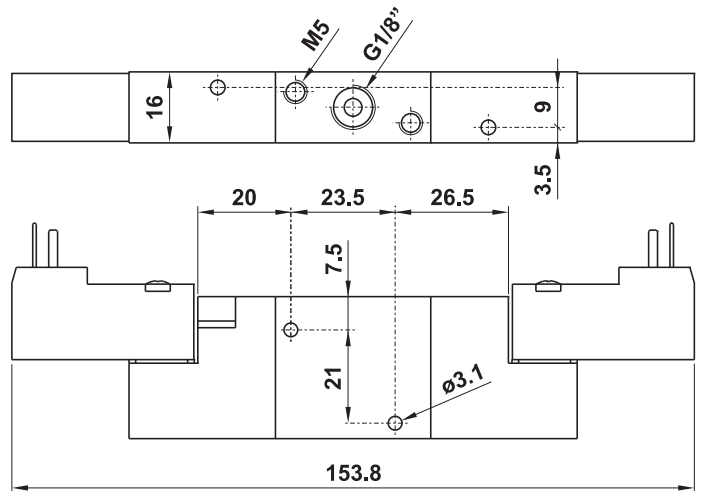
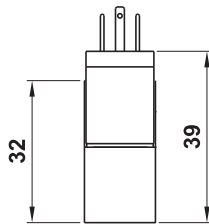

451 EE AS xx

5/2 1/8" doppio comando elettrico alimentazione separata

5/2 1/8" double solenoid pilot with separate air supply

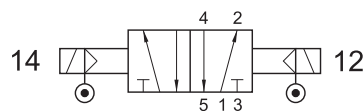

Nella sigla del prodotto sostituire le lettere "xx" con l'indicazione della tensione.
In the part number replace "xx" with the reference of the solenoid tension.

24V DC	01
24V 50/60Hz	02

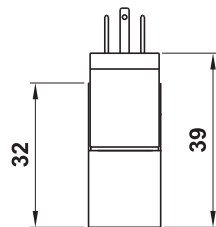

L'alimentazione separata funziona solo se la valvola è montata su sottobase modulare

The separate air supply works only if the valve is mounted on modular sub-base

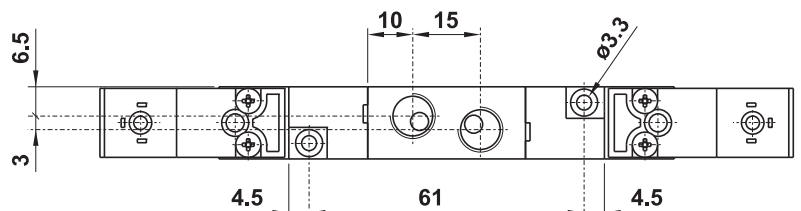
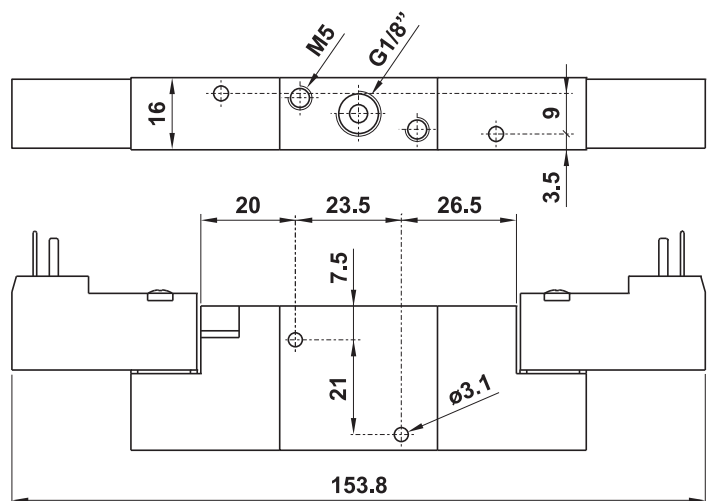

sottobasi per elettrovalvole 16 mm

manifolds for 16 mm solenoid valves



- Scarichi convogliati
Common exhaust
- Materiale: alluminio anodizzato
Material: aluminium (anodize treatment)
- Non utilizzabili per valvole alimentazione separata
Not suitable for valves with separate air supply
- Sottobasi speciali a richiesta
Special manifolds on request

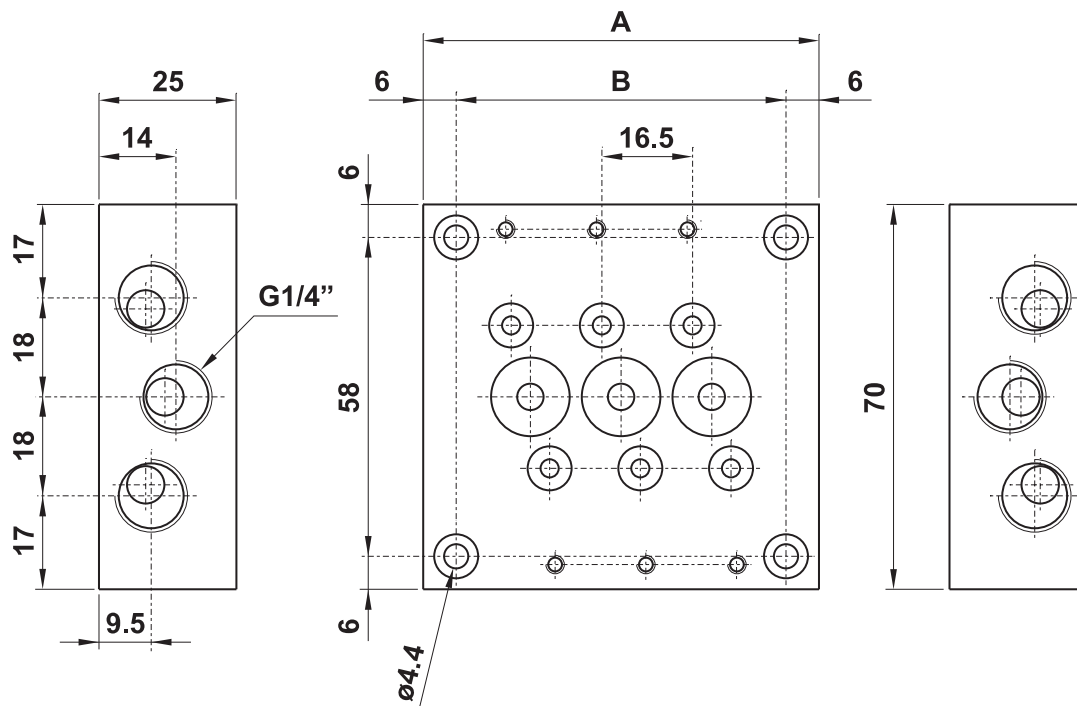
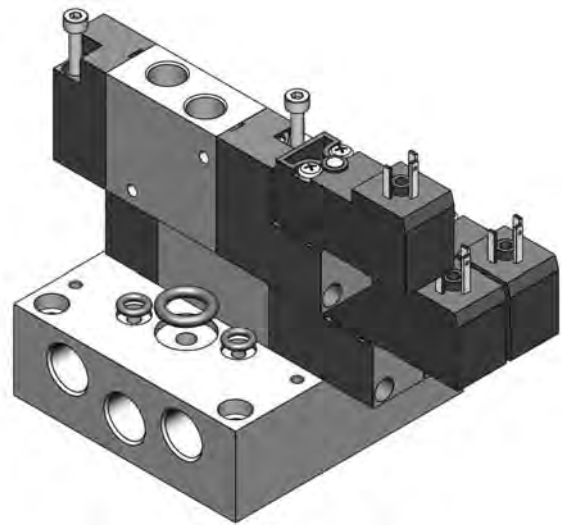

modello model	nr. posiz. no. stations	A	B
05.082.2	2	55.5	43.5
05.083.2	3	72	60
05.084.2	4	88.5	76.5
05.085.2	5	105	93
05.086.2	6	121.5	109.5
05.087.2	7	138	126
05.088.2	8	154.5	142.5
05.089.2	9	171	159
05.090.2	10	187.5	175.5
05.091.2	11	204	192
05.092.2	12	220.5	208.5

valvole ad azionamento elettropneumatico

solenoid actuated valves



- Valvole a spola 3/2-5/2-5/3 con attacchi filettati G1/8"-G1/4"
3/2-5/2-5/3 spool valves with G1/8"-G1/4" threaded ports
- Montaggio in linea, su collettori multipli o su basi manifold
Installation in-line, on gang or modular manifolds
- Comandi elettrici con azionamento manuale bistabile
Solenoid pilots with detented manual override as standard
- A richiesta versione a basso assorbimento 1.5W
On request with low consumption 1.5W
- Esecuzioni speciali a richiesta
Special versions on request

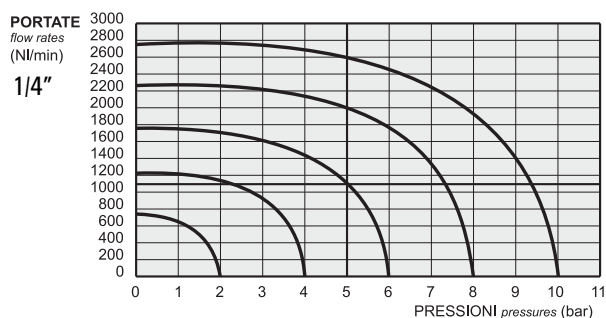
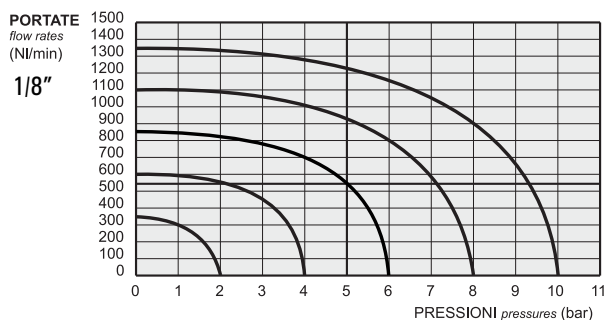

Materiali

Corpo: alluminio 11S

Comando e fondello: tecnopolimero (*)

Molle: INOX

Guarnizioni: NBR

Spola: alluminio nichelato

Parti interne: ottone OT58

Materials

Body: aluminium 11S

End cups: technopolymer (*)

Springs: stainless steel

Seals: NBR

Spool: nickel plated aluminium

Internal parts: brass OT58

(*) Su richiesta e dietro supplemento di prezzo, le valvole sono fornibili con corpo, comando e fondello interamente in alluminio. Alcune valvole, come di seguito specificato, sono disponibili solo nella versione in alluminio. Le valvole ATEX sono solo in alluminio.

Le parti in tecnopolimero recano impresso il logo

(*) On request and upon extra charge, the valves are available also with body and end caps entirely in aluminium. Some valves, as specified in the next pages, are available only in the aluminium version. ATEX valves are only in aluminium.

The parts in technopolymer are marked with the logo

Tempi di risposta - response times

	1/8"	1/4"
monostabile <i>mono-stable</i>	TRA (14): 15 ms TRR (12): 35 ms	TRA (14): 19 ms TRR (12): 45 ms
bistabile <i>bi-stable</i>	TRA (14): 20 ms TRR (12): 20 ms	TRA (14): 22 ms TRR (12): 22 ms

I prodotti di seguito indicati sono venduti senza bobine, da acquistarsi separatamente (vedi pag. 209).
The following listed products are sold without coils, which are bought separately (refer to page 209).

Diametro nominale <i>Nominal orifice</i>	1/8": 5 mm 1/4": 7.5 mm		
Temperatura di esercizio <i>Temperature range</i>	max +60°C		
Pressione di esercizio <i>Working pressure</i>	al. interna monost. [monost. internal air supply]	al. interna bist. [bi-stable internal air supply]	alim. separata [separate air supply]
	2.5 ... 10 bar 0.25 ... 1 MPa	1 ... 10 bar 0.1 ... 1 MPa	-0.9 ... 10 bar -0.09 ... 1 MPa
Pressione di azionamento (per alimentazione separata) <i>Actuating pressure (for separate air supply)</i>	monostabile [mono-stable]		bistabile [bi-stable]
	2.5 ... 10 bar 0.25 ... 1 MPa		1 ... 10 bar 0.1 ... 1 MPa
Fluido <i>Fluid</i>	Aria filtrata 50µ con o senza lubrificazione <i>50µ filtered, lubricated or non lubricated air</i>		

valvole ad azionamento elettropneumatico

solenoid actuated valves



321 ME

3/2 1/8" NC comando elettrico - ritorno a molla

3/2 1/8" NC solenoid pilot - spring return

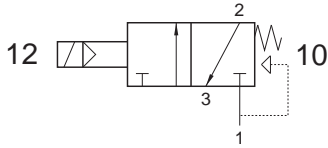

Non può essere utilizzata come valvola normalmente aperta.
It cannot be used as normally open valve.

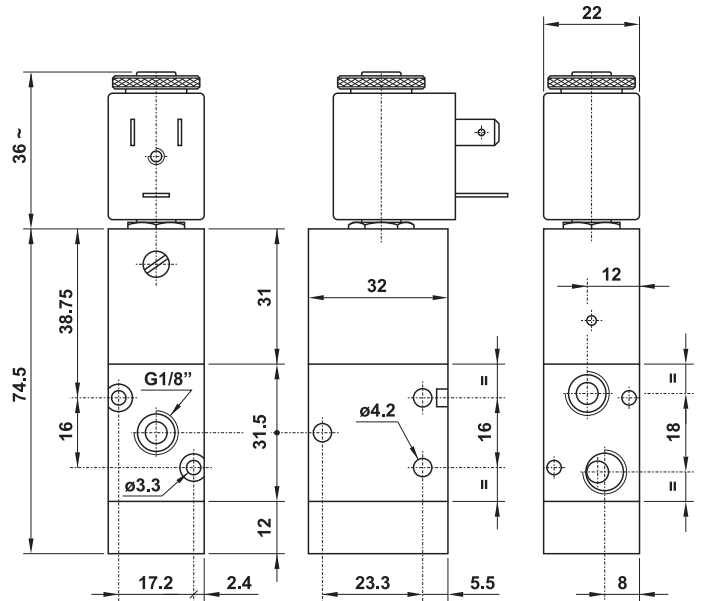

321 MEA

3/2 1/8" NA comando elettrico - ritorno a molla

3/2 1/8" NO solenoid pilot - spring return

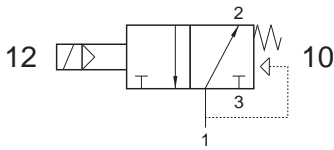

Non può essere utilizzata come valvola normalmente chiusa.
It cannot be used as normally closed valve.

SOLO VERSIONE IN ALLUMINIO
ONLY ALUMINIUM VERSION

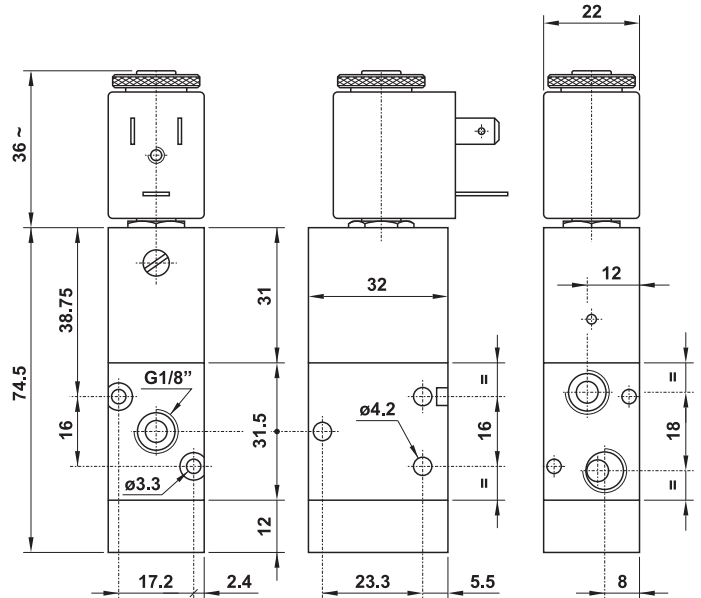

321 CE

3/2 1/8" comando elettrico - ritorno a comando pneumatico

3/2 1/8" solenoid pilot - separate pneumatically piloted return

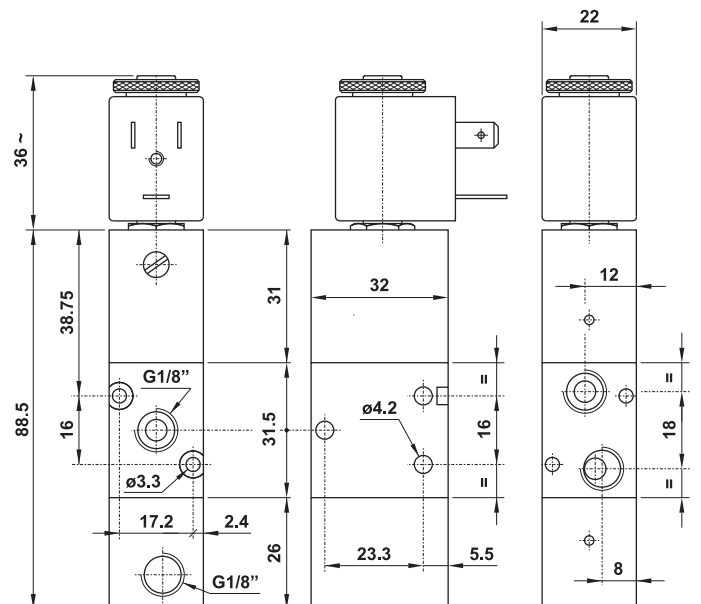
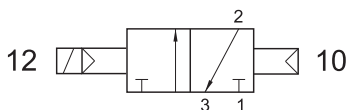

valvole ad azionamento elettropneumatico

solenoid actuated valves



521 ME

5/2 1/8" comando elettrico - ritorno a molla

5/2 1/8" solenoid pilot - spring return

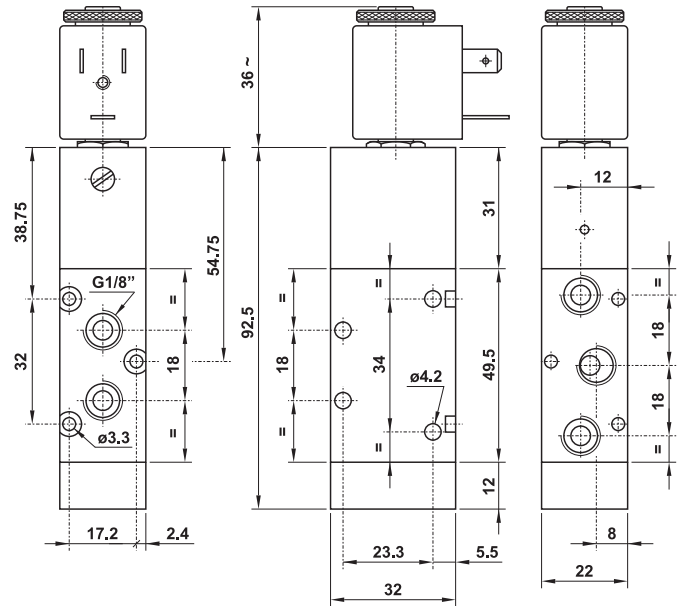
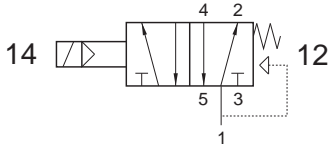

521 CE

5/2 1/8" comando elettrico - ritorno a comando pneumatico

5/2 1/8" solenoid pilot - separate pneumatically piloted return

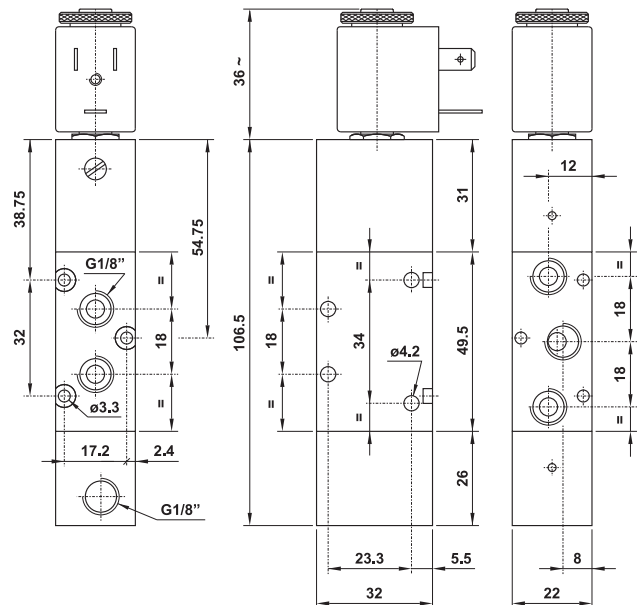
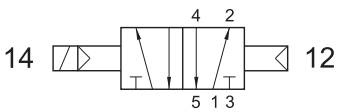

321 ME AS

3/2 1/8" comando elettrico alimentazione separata - ritorno a molla

3/2 1/8" solenoid pilot with separate air supply - spring return

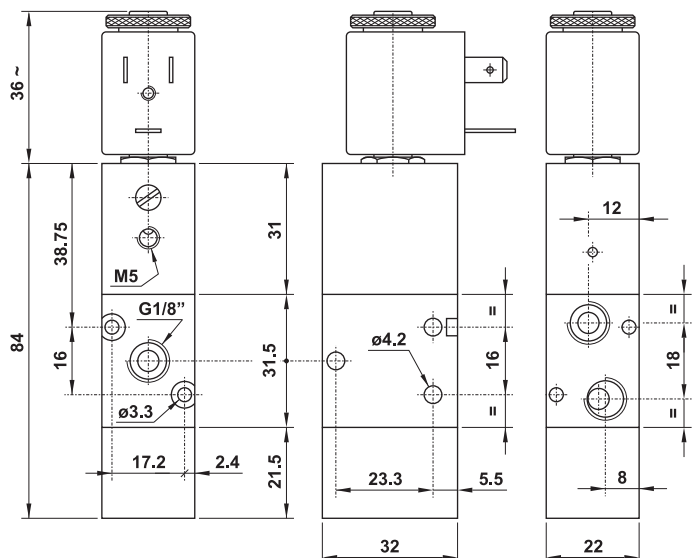
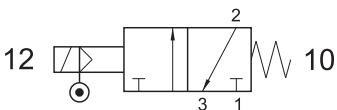

valvole ad azionamento elettropneumatico

solenoid actuated valves



521 ME AS

5/2 1/8" comando elettrico alimentazione separata - ritorno a molla

5/2 1/8" solenoid pilot with separate air supply - spring return

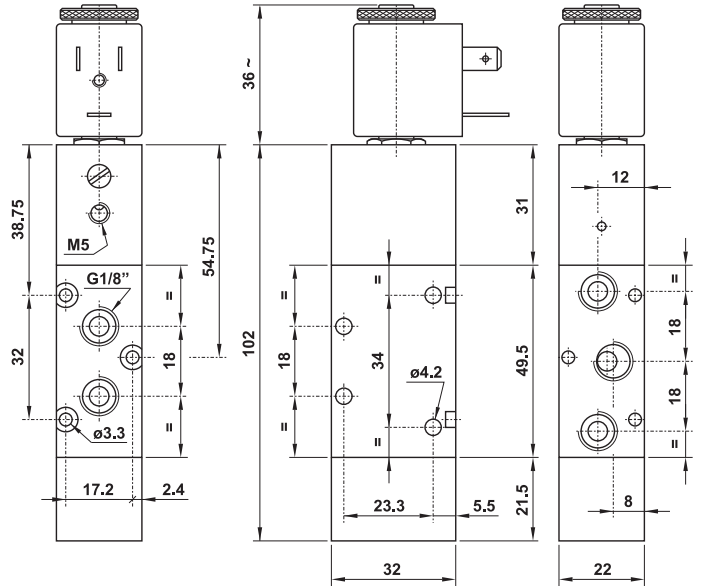
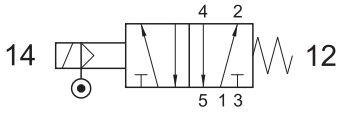

321 EE

3/2 1/8" doppio comando elettrico

3/2 1/8" double solenoid pilot

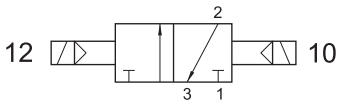

SOLO VERSIONE IN ALLUMINIO
ONLY ALUMINIUM VERSION

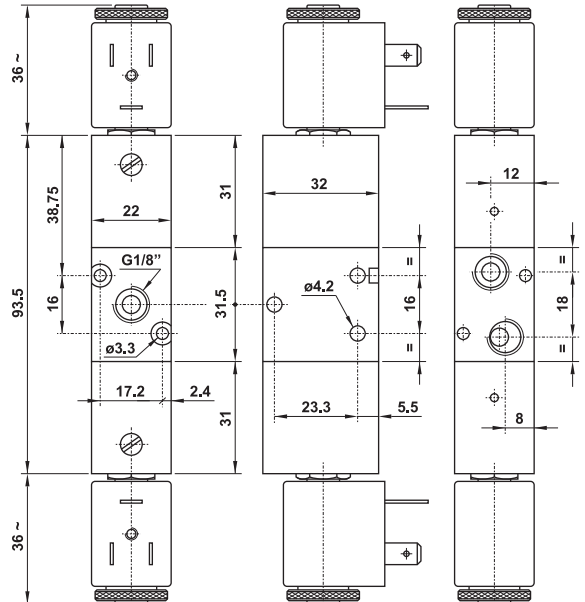

321 EED

3/2 1/8" doppio comando elettrico - con differenziale

3/2 1/8" double solenoid pilot - with differential

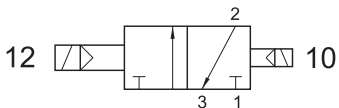

SOLO VERSIONE IN ALLUMINIO
ONLY ALUMINIUM VERSION

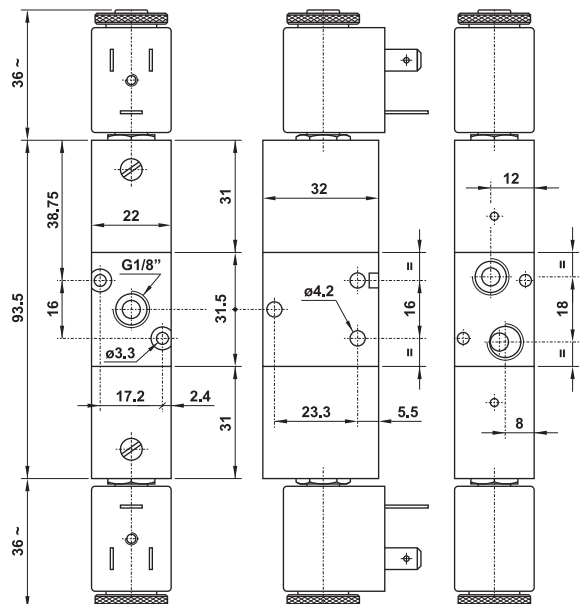

valvole ad azionamento elettropneumatico

solenoid actuated valves



321 EFP

3/2 1/8" NC comando elettrico - ritorno a molla pneumatica

3/2 1/8" NC solenoid pilot - pneumatic spring return

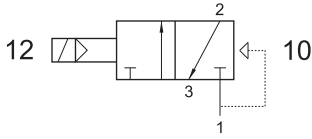

Non può essere utilizzata come valvola normalmente aperta.
It cannot be used as normally open valve.

SOLO VERSIONE IN ALLUMINIO
ONLY ALUMINIUM VERSION

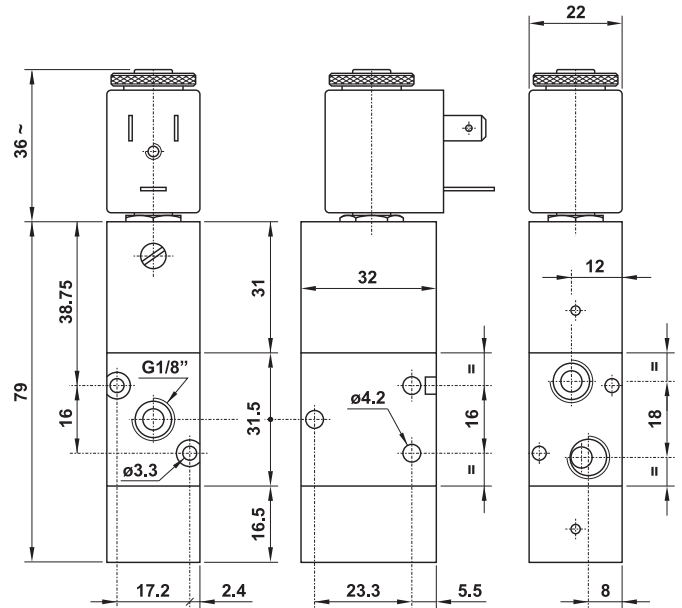

521 EE

5/2 1/8" doppio comando elettrico

5/2 1/8" double solenoid pilot

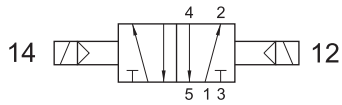

SOLO VERSIONE IN ALLUMINIO
ONLY ALUMINIUM VERSION

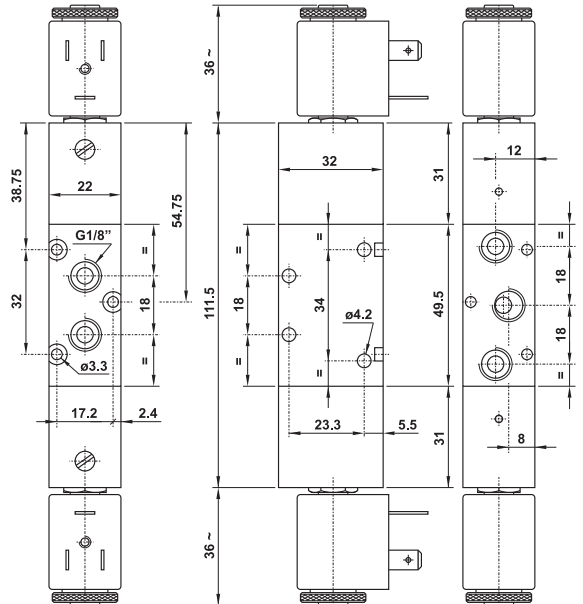

521 EED

5/2 1/8" doppio comando elettrico - con differenziale

5/2 1/8" double solenoid pilot - with differential

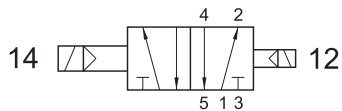

SOLO VERSIONE IN ALLUMINIO
ONLY ALUMINIUM VERSION

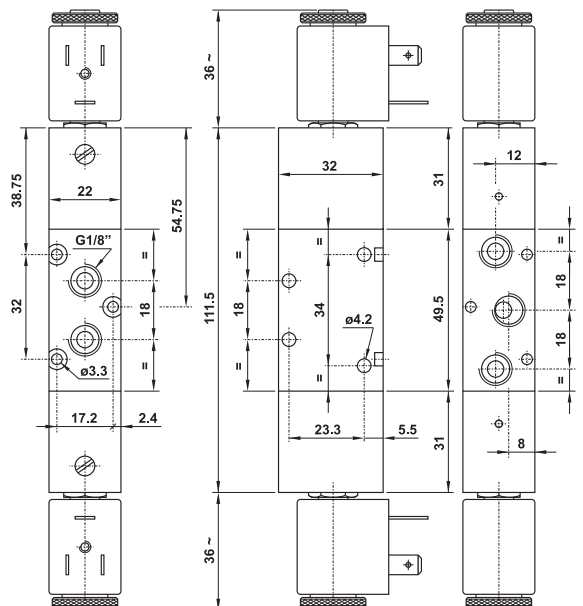

valvole ad azionamento elettropneumatico

solenoid actuated valves



521 EFP

5/2 1/8" comando elettrico - ritorno a molla pneumatica

5/2 1/8" solenoid pilot - pneumatic spring return

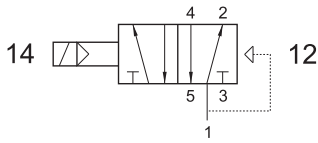

SOLO VERSIONE IN ALLUMINIO
ONLY ALUMINIUM VERSION

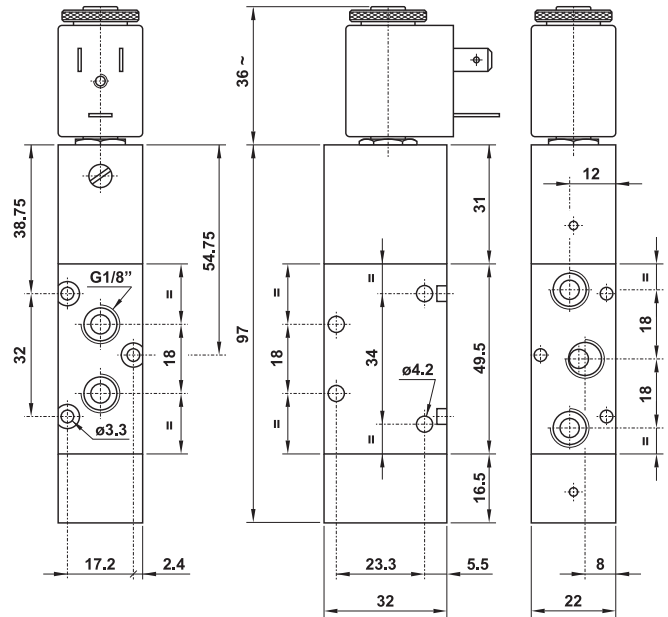

321 EE AS

3/2 1/8" doppio comando elettrico alimentazione separata

3/2 1/8" double solenoid pilot with separate air supply

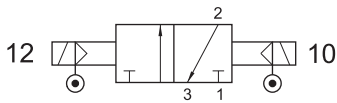

SOLO VERSIONE IN ALLUMINIO
ONLY ALUMINIUM VERSION

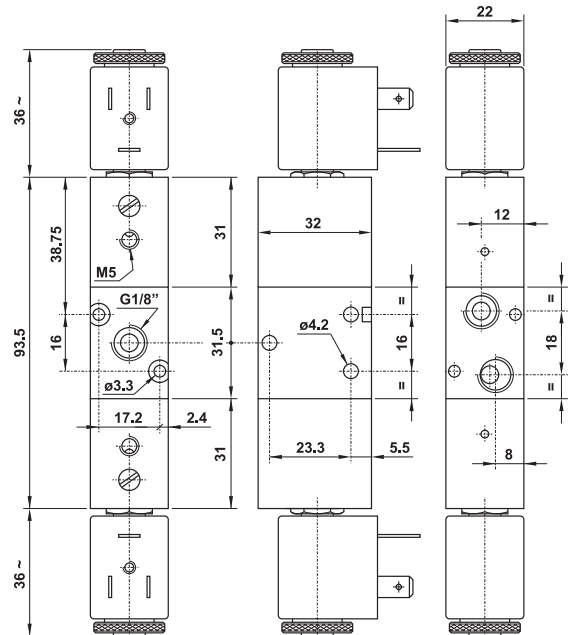

521 EE AS

5/2 1/8" doppio comando elettrico alimentazione separata

5/2 1/8" double solenoid pilot with separate air supply

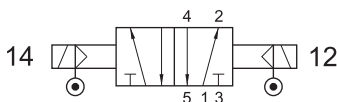

SOLO VERSIONE IN ALLUMINIO
ONLY ALUMINIUM VERSION

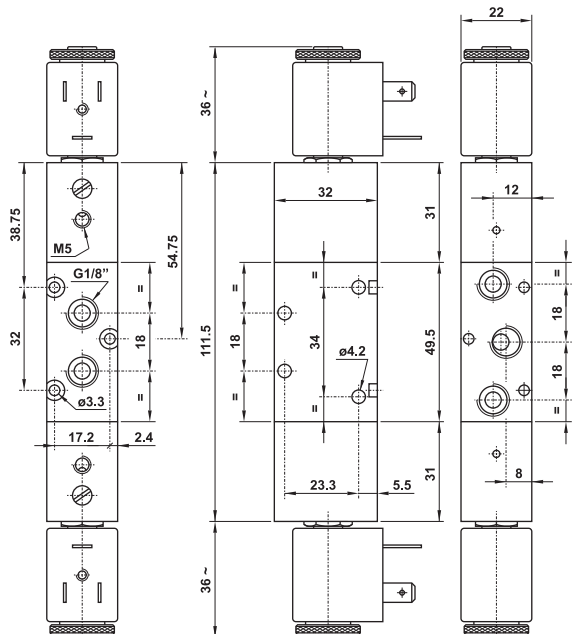

valvole ad azionamento elettropneumatico

solenoid actuated valves



5213C EE centri chiusi
closed centres

5213A EE centri aperti
open centres

5213P EE centri in pressione
pressurized centres

5/3 1/8" doppio comando elettrico

5/3 1/8" double solenoid pilot

SOLO VERSIONE IN ALLUMINIO

ONLY ALUMINIUM VERSION

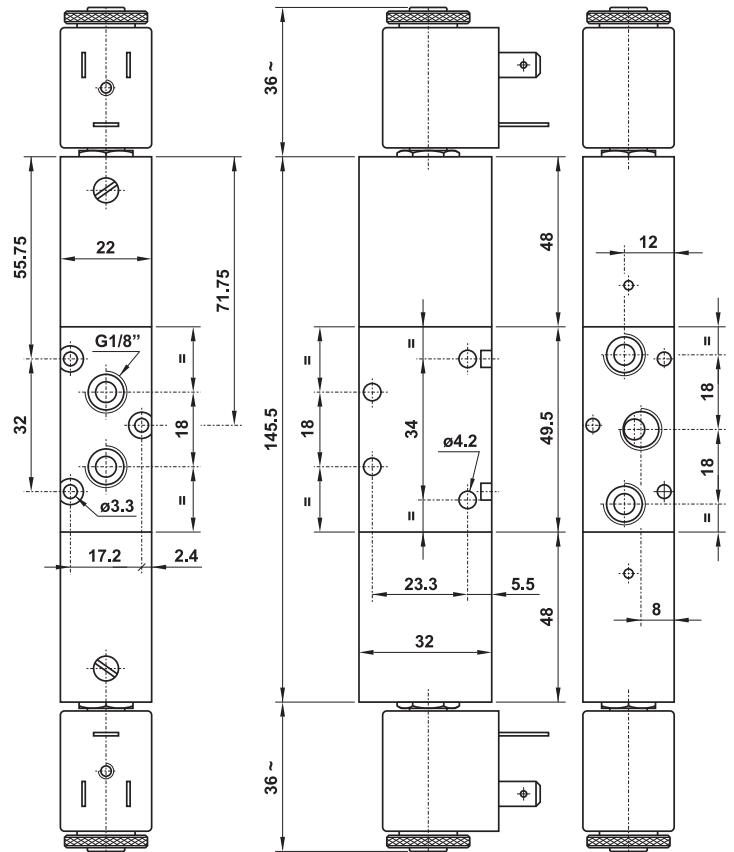
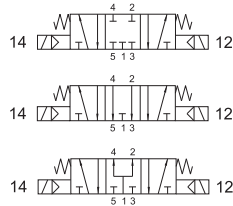

5213C EE AS centri chiusi
closed centres

5213A EE AS centri aperti
open centres

5213P EE AS centri in pressione
pressurized centres

5/3 1/8" doppio comando elettrico alimentazione separata

5/3 1/8" double solenoid pilot with separate air supply

SOLO VERSIONE IN ALLUMINIO

ONLY ALUMINIUM VERSION

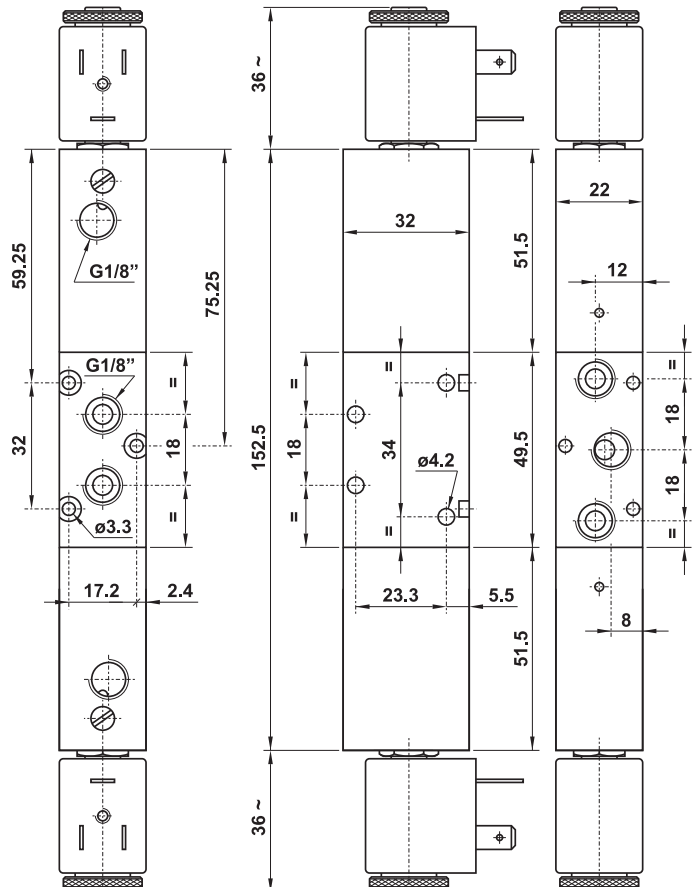
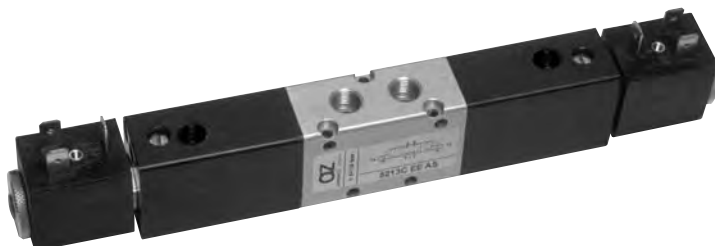
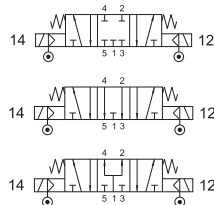

valvole ad azionamento elettropneumatico

solenoid actuated valves



321 MRE

3/2 1/8" NC comando elettrico - ritorno a molla RINFORZATA

3/2 1/8" NC solenoid pilot - REINFORCED spring return

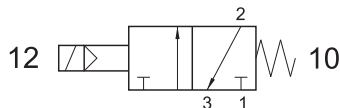

Non può essere utilizzata come valvola normalmente aperta.
It cannot be used as normally open valve.

Pressione di esercizio: 2.5 ... 10 bar

Working pressure: 2.5 ... 10 bar

La molla rinforzata permette un ritorno efficace della spola anche in assenza di aria.
The reinforced spring allows a prompt return of the spool also in lack of air.

Attenzione: il fondello per molla rinforzata è più lungo rispetto al fondello di una valvola con ritorno a molla normale.

Attention: the bottom end cap for reinforced spring return is longer than the end cap for normal spring return.

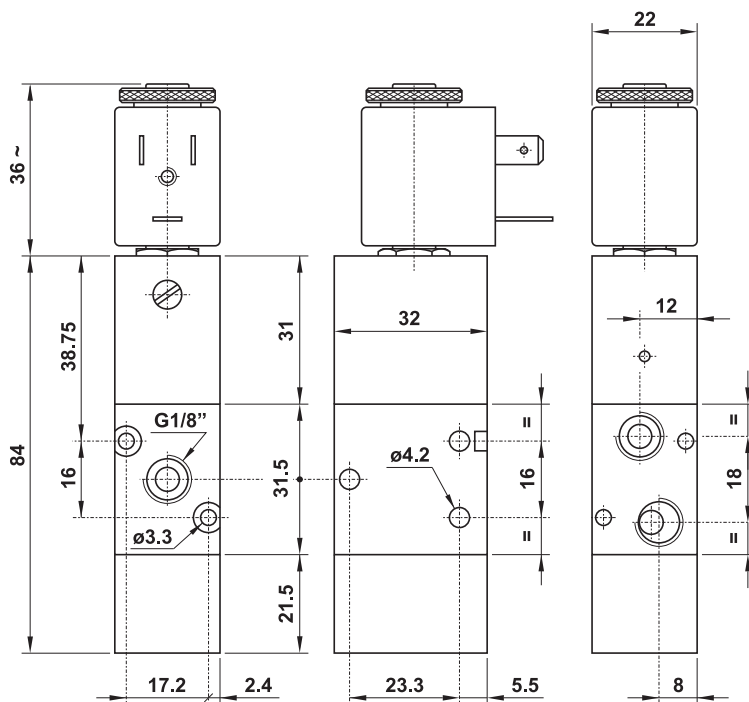

521 MRE

5/2 1/8" comando elettrico - ritorno a molla RINFORZATA

5/2 1/8" solenoid pilot - REINFORCED spring return

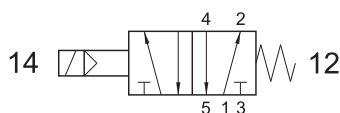

Pressione di esercizio: 2.5 ... 10 bar

Working pressure: 2.5 ... 10 bar

La molla rinforzata permette un ritorno efficace della spola anche in assenza di aria.
The reinforced spring allows a prompt return of the spool also in lack of air.

Attenzione: il fondello per molla rinforzata è più lungo rispetto al fondello di una valvola con ritorno a molla normale.

Attention: the bottom end cap for reinforced spring return is longer than the end cap for normal spring return.

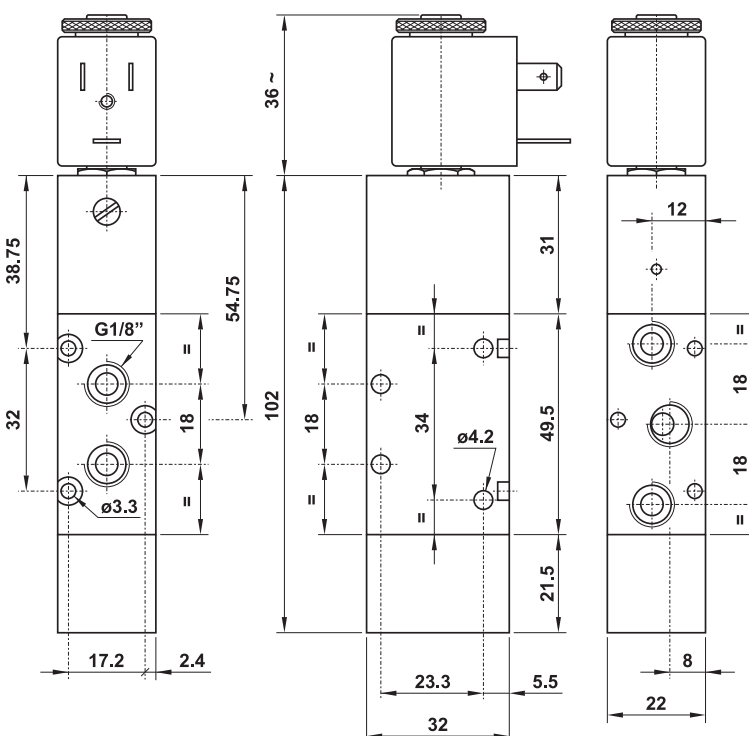

valvole ad azionamento elettropneumatico

solenoid actuated valves



321 ME90 S

3/2 1/8" NC comando elettrico 90° sul lato stretto - ritorno a molla
3/2 1/8" NC 90° solenoid pilot on the narrow side for compact assembly - spring return

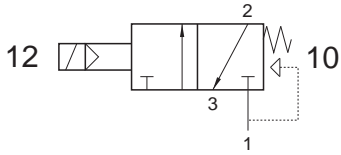

Non può essere utilizzata come valvola normalmente aperta.
It cannot be used as normally open valve.

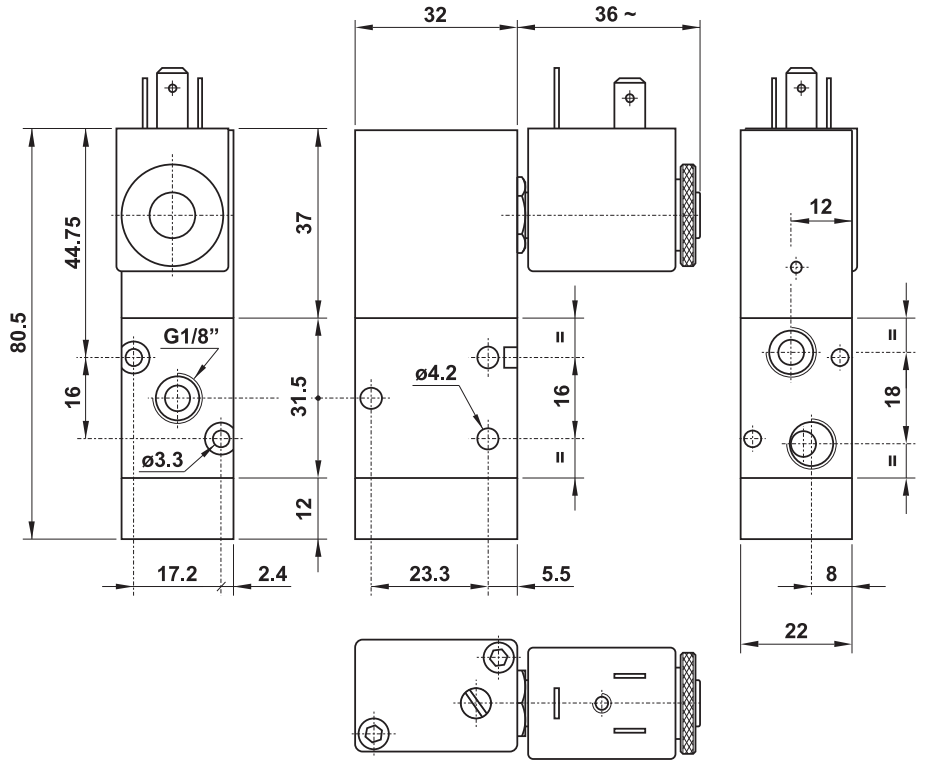

321 ME90 L

3/2 1/8" NC comando elettrico 90° sul lato largo - ritorno a molla
3/2 1/8" NC 90° solenoid pilot on the wide side - spring return

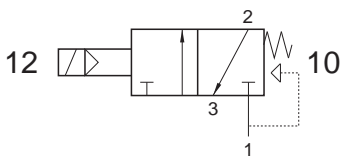

Non può essere utilizzata come valvola normalmente aperta.
It cannot be used as normally open valve.

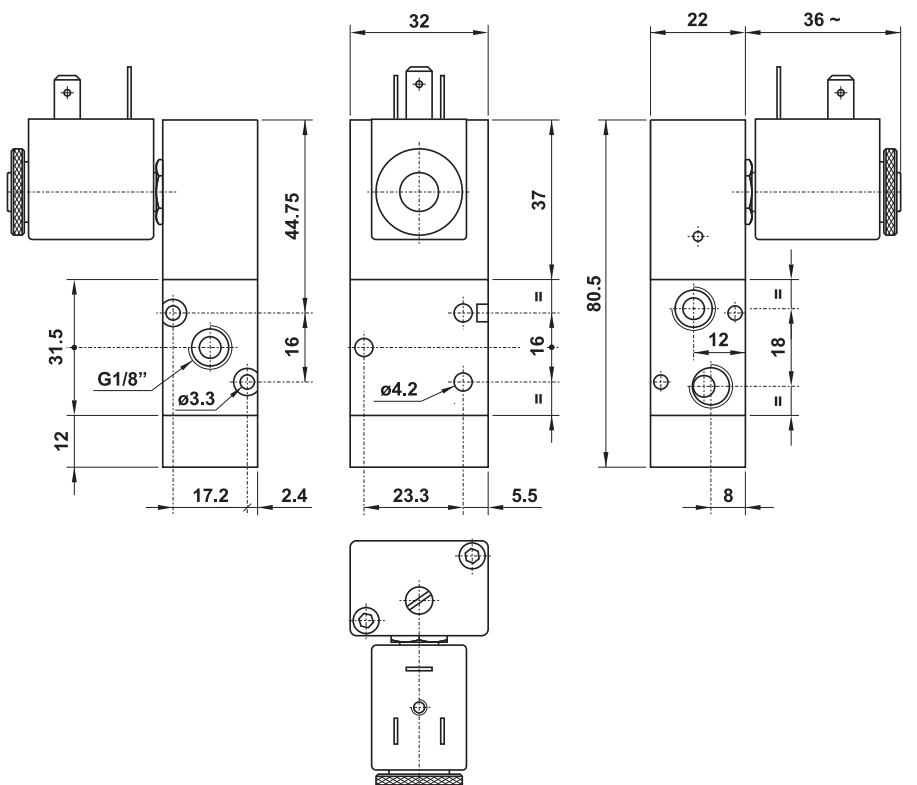

521 ME90 S

5/2 1/8" comando elettrico 90° sul lato stretto - ritorno a molla

5/2 1/8" 90° solenoid pilot on the narrow side for compact assembly - spring return

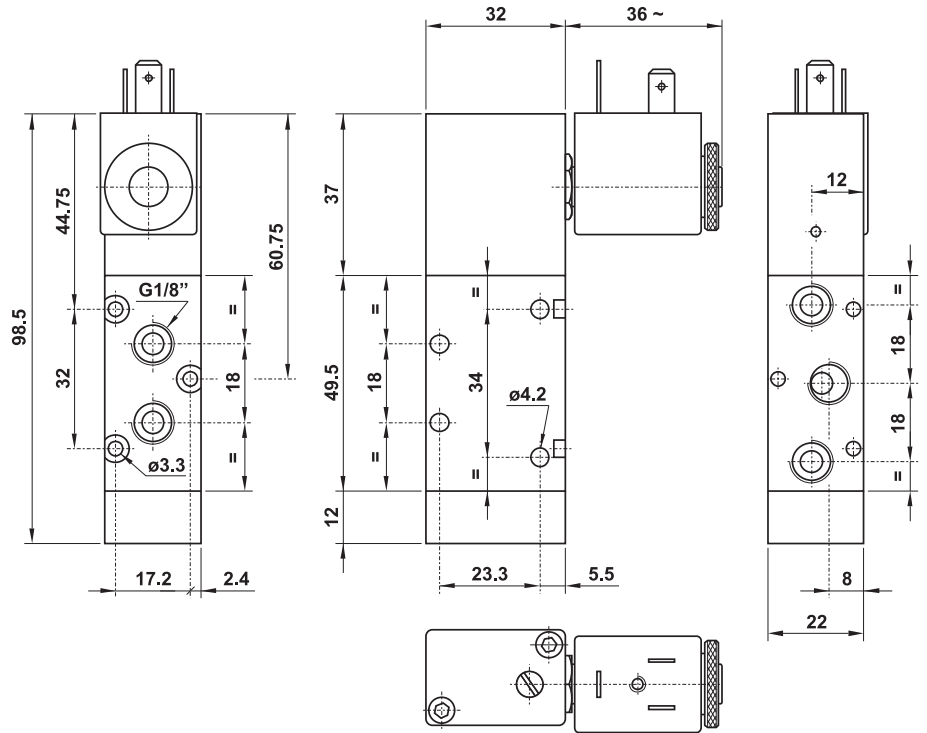
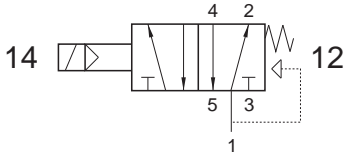

521 ME90 L

5/2 1/8" comando elettrico 90° sul lato largo - ritorno a molla

5/2 1/8" 90° solenoid pilot on the wide side - spring return

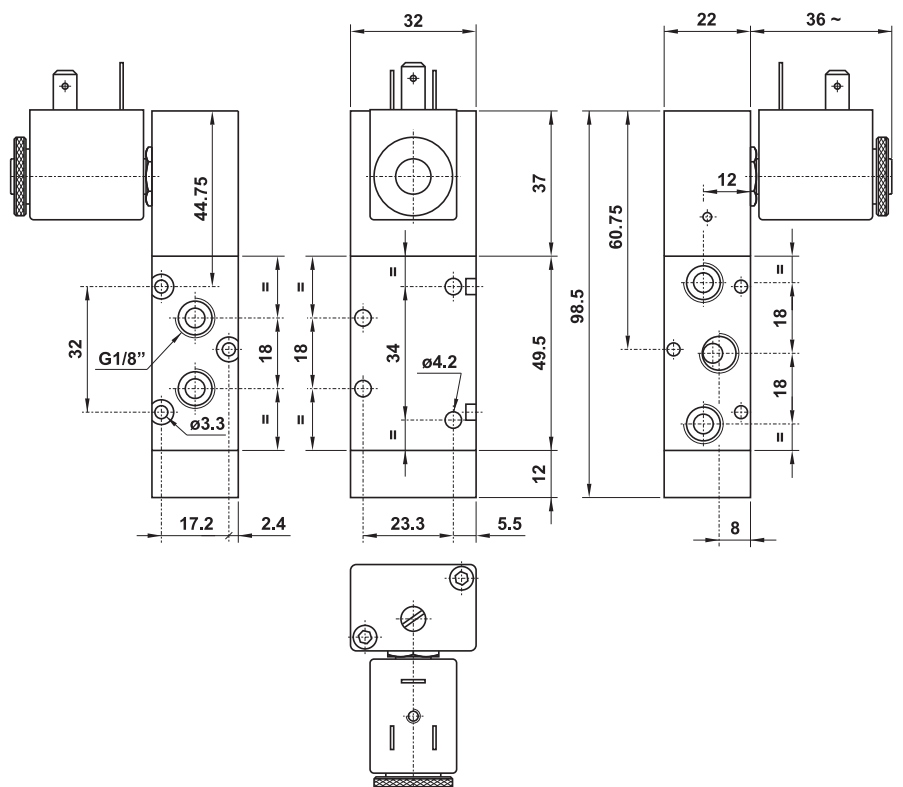
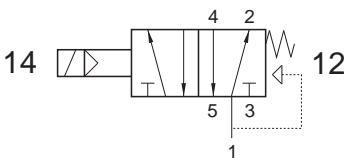

321 EE90 S

3/2 1/8" doppio comando elettrico 90° sul lato stretto

3/2 1/8" 90° double solenoid pilot on the narrow side for compact assembly

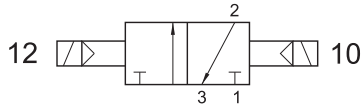

SOLO VERSIONE IN ALLUMINIO
ONLY ALUMINIUM VERSION

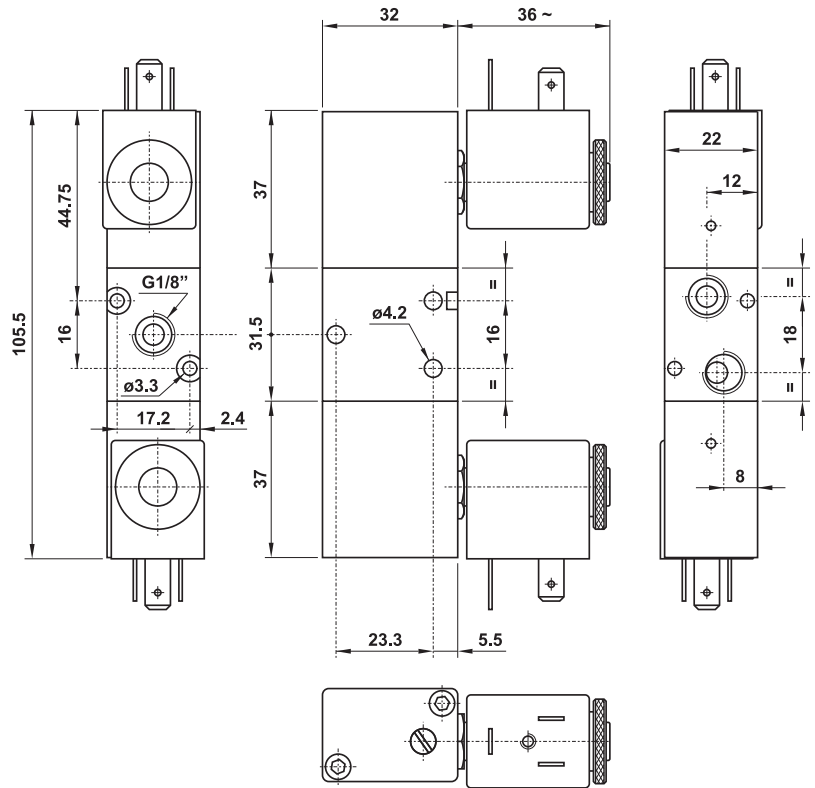

321 EE90 L

3/2 1/8" doppio comando elettrico 90° sul lato largo

3/2 1/8" 90° double solenoid pilot on the wide side

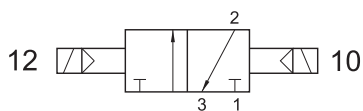

SOLO VERSIONE IN ALLUMINIO
ONLY ALUMINIUM VERSION

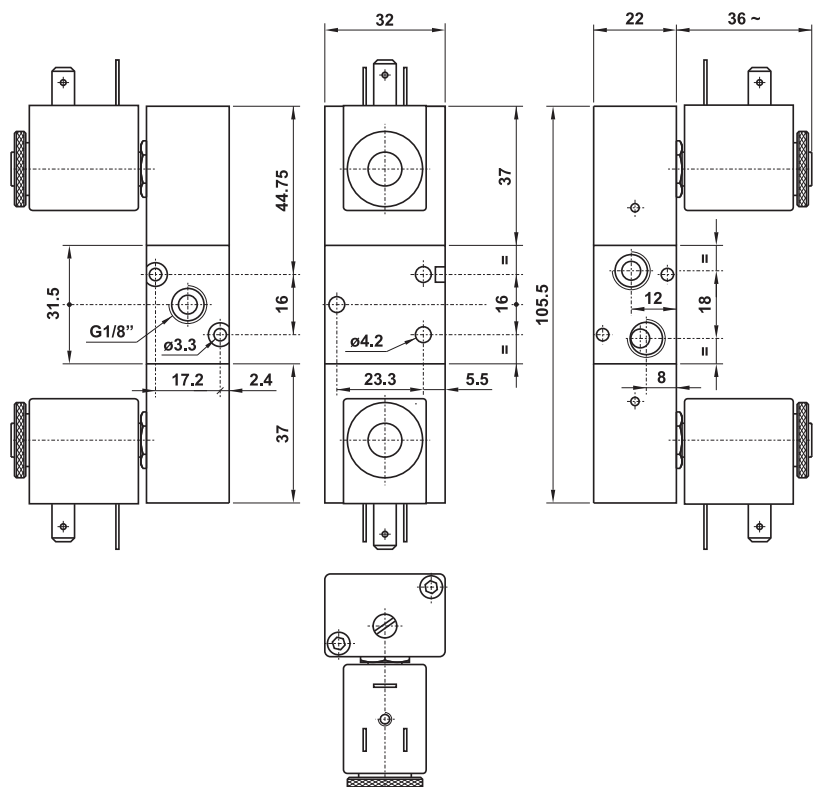

521 EE90 S

5/2 1/8" doppio comando elettrico 90° sul lato stretto

5/2 1/8" 90° double solenoid pilot on the narrow side for compact assembly

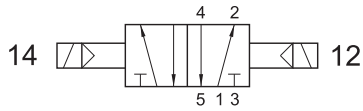

SOLO VERSIONE IN ALLUMINIO
ONLY ALUMINIUM VERSION

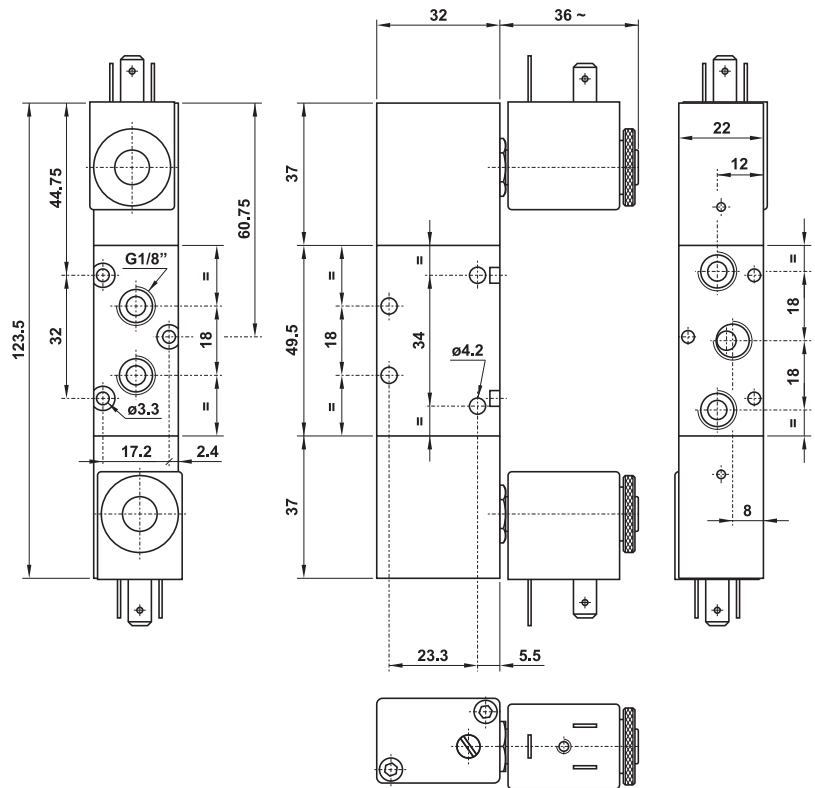

521 EE90 L

5/2 1/8" doppio comando elettrico 90° sul lato largo

5/2 1/8" 90° double solenoid pilot on the wide side

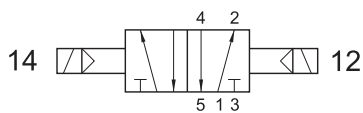

SOLO VERSIONE IN ALLUMINIO
ONLY ALUMINIUM VERSION

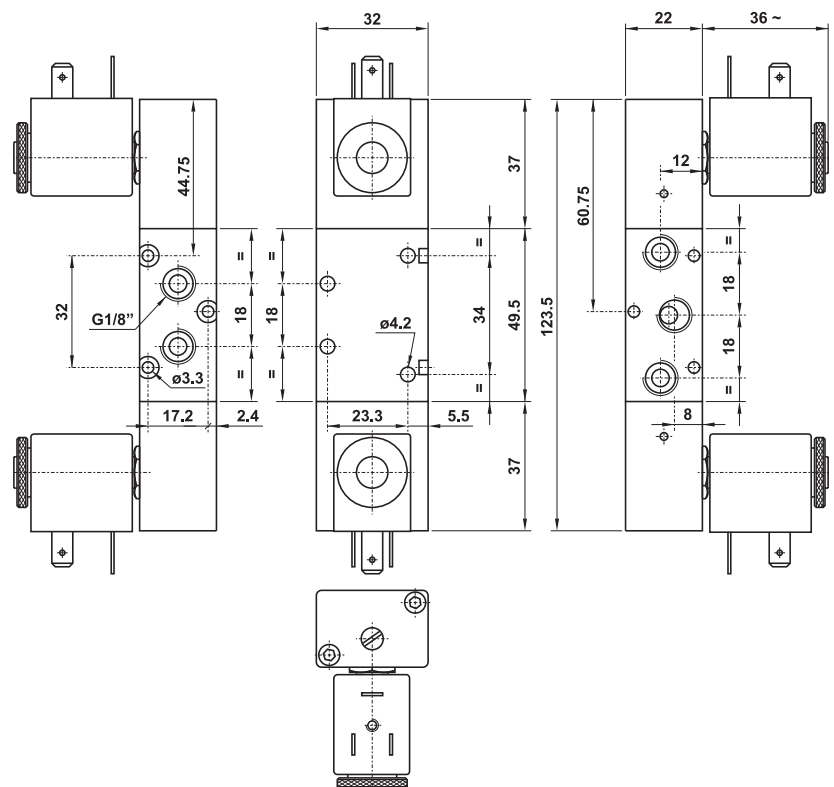
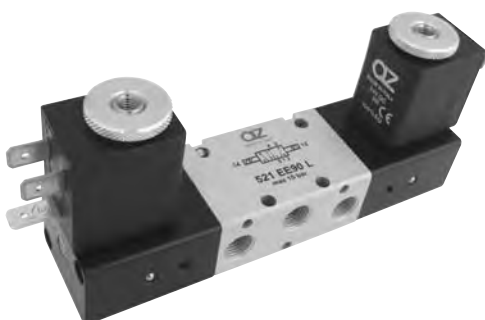

valvole ad azionamento elettropneumatico

solenoid actuated valves



322 ME

3/2 1/4" NC comando elettrico - ritorno a molla

3/2 1/4" NC solenoid pilot - spring return

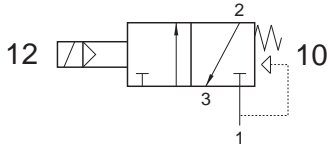

Non può essere utilizzata come valvola normalmente aperta.
It cannot be used as normally open valve.

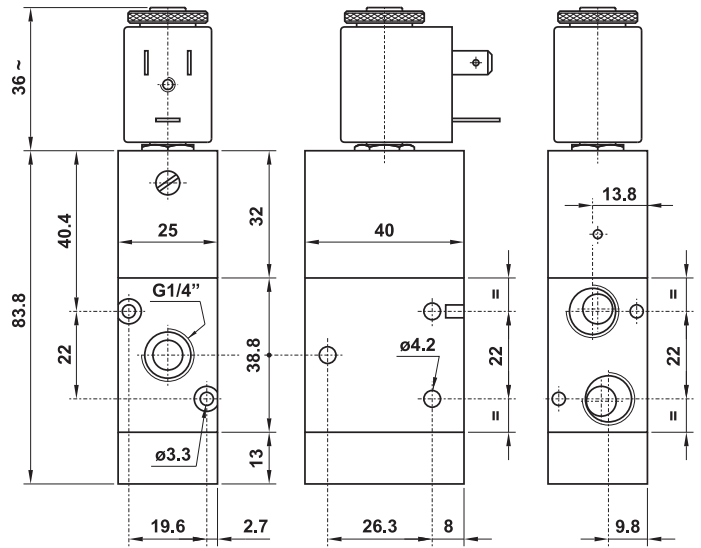

322 MEA

3/2 1/4" NA comando elettrico - ritorno a molla

3/2 1/4" NO solenoid pilot - spring return

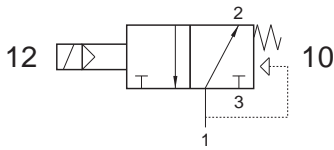

Non può essere utilizzata come valvola normalmente chiusa.
It cannot be used as normally closed valve.

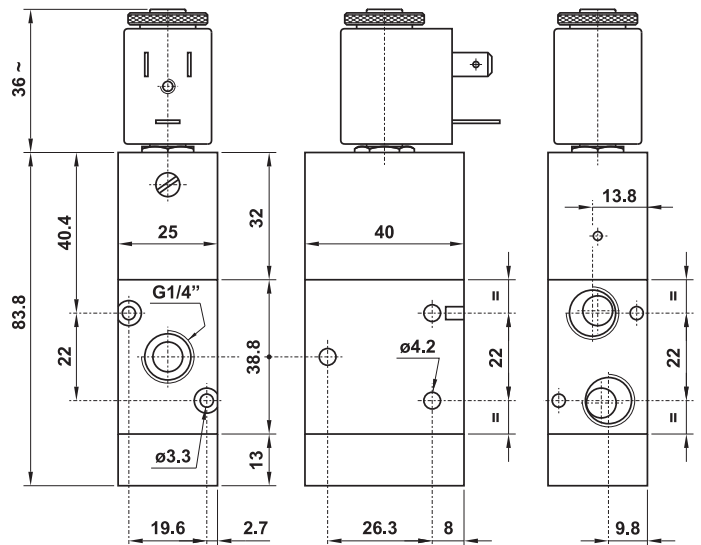

322 CE

3/2 1/4" comando elettrico - ritorno a comando pneumatico

3/2 1/4" solenoid pilot - separate pneumatically piloted return

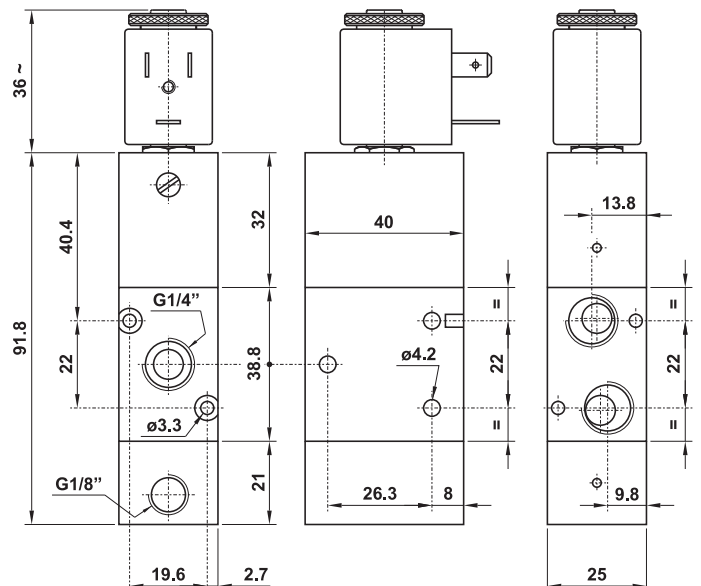
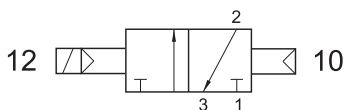

valvole ad azionamento elettropneumatico

solenoid actuated valves



522 ME

5/2 1/4" comando elettrico - ritorno a molla

5/2 1/4" solenoid pilot - spring return

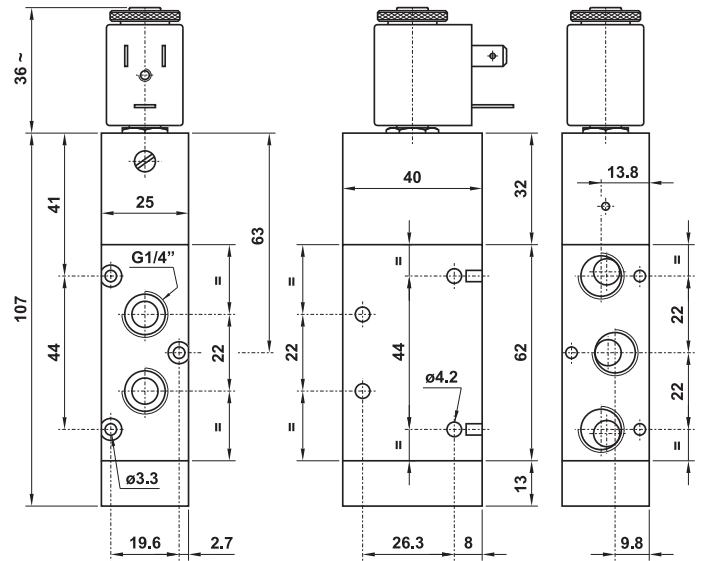
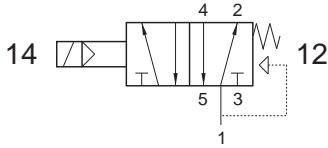

522 CE

5/2 1/4" comando elettrico - ritorno a comando pneumatico

5/2 1/4" solenoid pilot - separate pneumatically piloted return

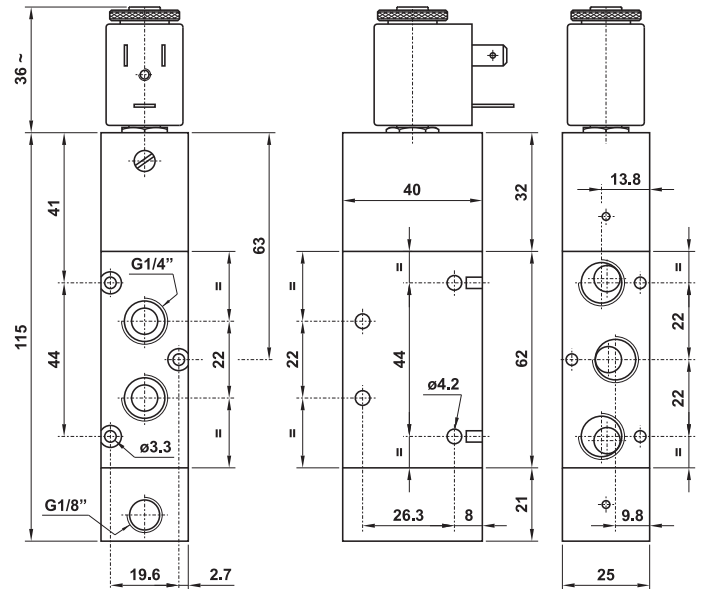
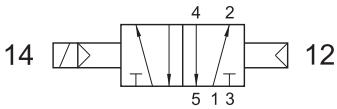

322 ME AS

3/2 1/4" comando elettrico alimentazione separata - ritorno a molla

3/2 1/4" solenoid pilot with separate air supply - spring return

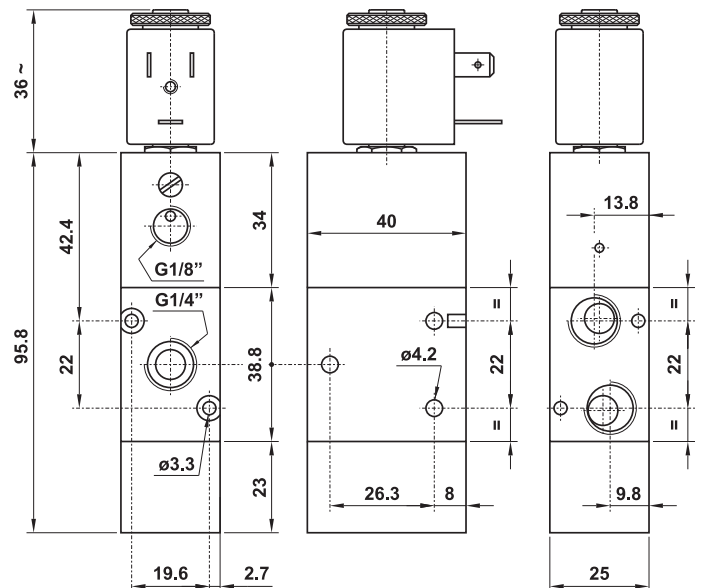
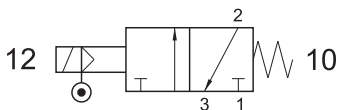

valvole ad azionamento elettropneumatico

solenoid actuated valves



522 ME AS

5/2 1/4" comando elettrico alimentazione separata - ritorno a molla
 5/2 1/4" solenoid pilot with separate air supply - spring return

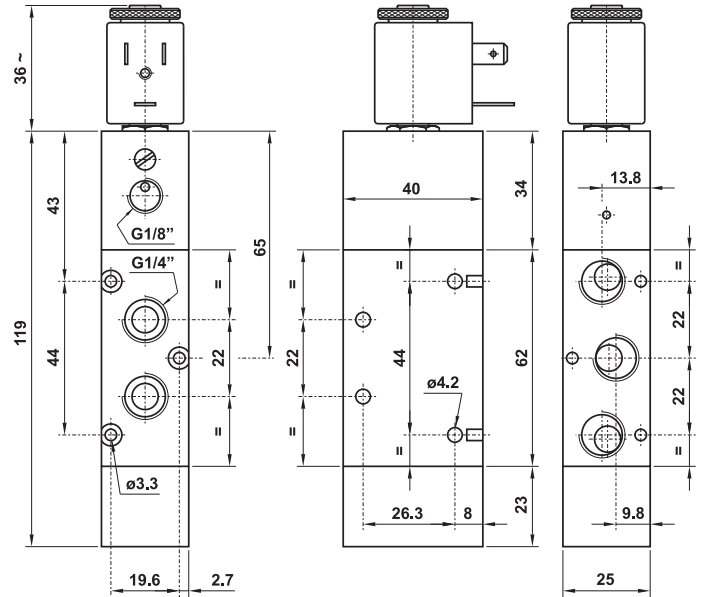
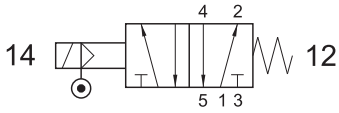

322 EE

3/2 1/4" doppio comando elettrico
 3/2 1/4" double solenoid pilot

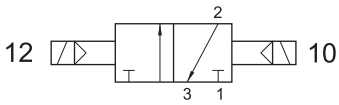

SOLO VERSIONE IN ALLUMINIO
 ONLY ALUMINIUM VERSION

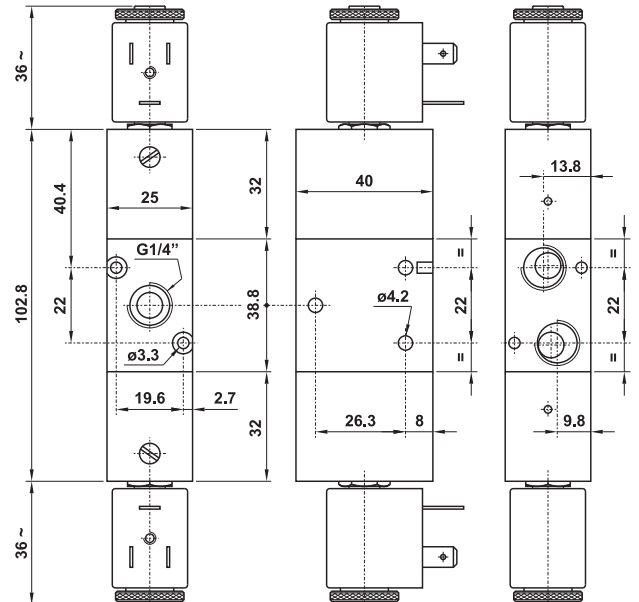

322 EED

3/2 1/4" doppio comando elettrico - con differenziale
 3/2 1/4" double solenoid pilot - with differential

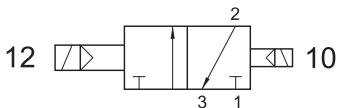

SOLO VERSIONE IN ALLUMINIO
 ONLY ALUMINIUM VERSION

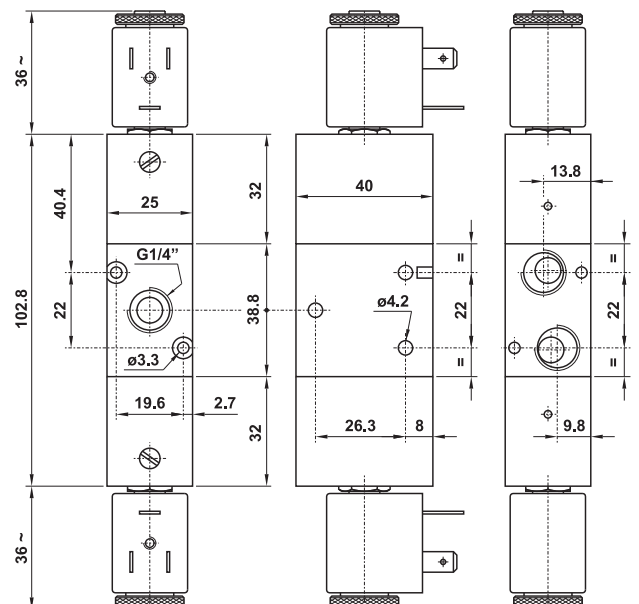

valvole ad azionamento elettropneumatico

solenoid actuated valves



322 EFP

3/2 1/4" NC comando elettrico - ritorno a molla pneumatica

3/2 1/4" NC solenoid pilot - pneumatic spring return

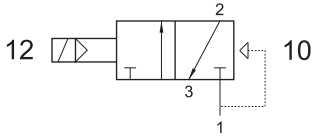

Non può essere utilizzata come valvola normalmente aperta.
It cannot be used as normally open valve.

SOLO VERSIONE IN ALLUMINIO
ONLY ALUMINIUM VERSION

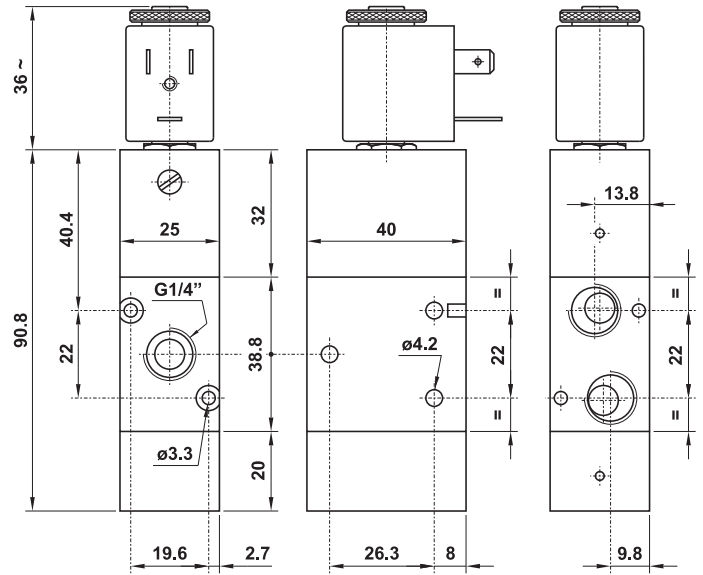

522 EE

5/2 1/4" doppio comando elettrico

5/2 1/4" double solenoid pilot

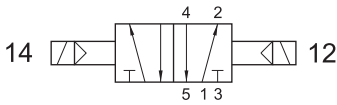

SOLO VERSIONE IN ALLUMINIO
ONLY ALUMINIUM VERSION

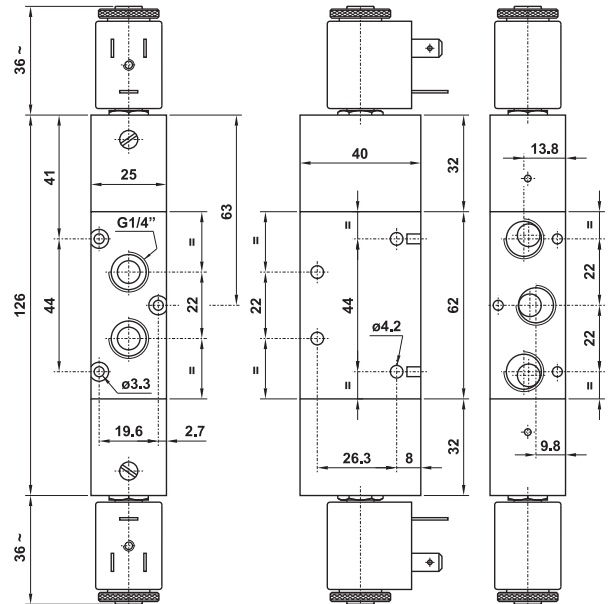

522 EED

5/2 1/4" doppio comando elettrico - con differenziale

5/2 1/4" double solenoid pilot - with differential

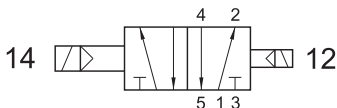

SOLO VERSIONE IN ALLUMINIO
ONLY ALUMINIUM VERSION

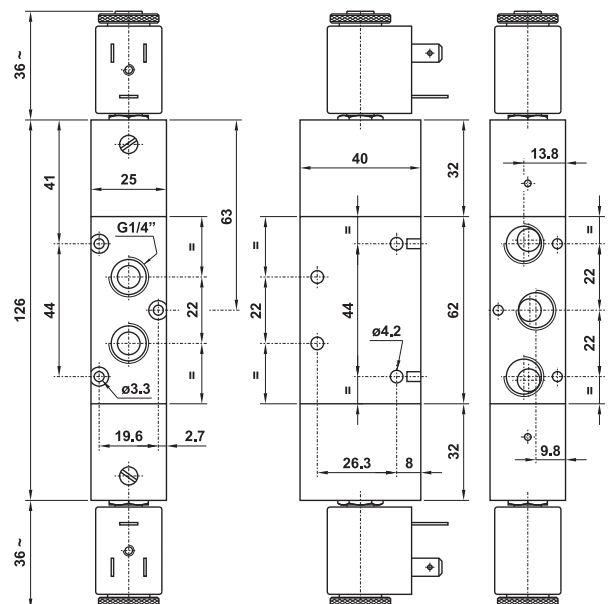

valvole ad azionamento elettropneumatico

solenoid actuated valves



522 EFP

5/2 1/4" comando elettrico - ritorno a molla pneumatica

5/2 1/4" solenoid pilot - pneumatic spring return

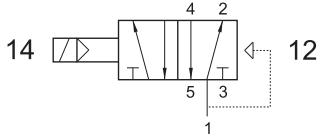

SOLO VERSIONE IN ALLUMINIO
ONLY ALUMINIUM VERSION

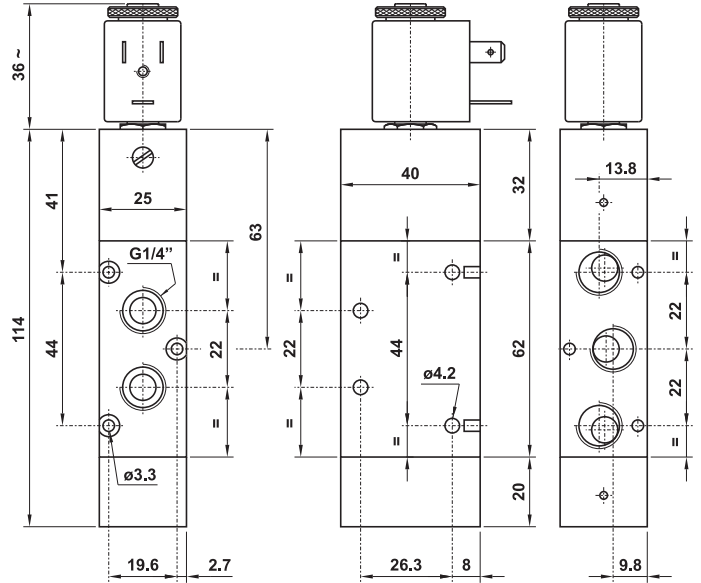

322 EE AS

3/2 1/4" doppio comando elettrico alimentazione separata

3/2 1/4" double solenoid pilot with separate air supply

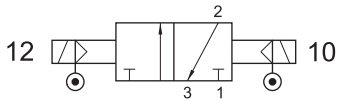

SOLO VERSIONE IN ALLUMINIO
ONLY ALUMINIUM VERSION

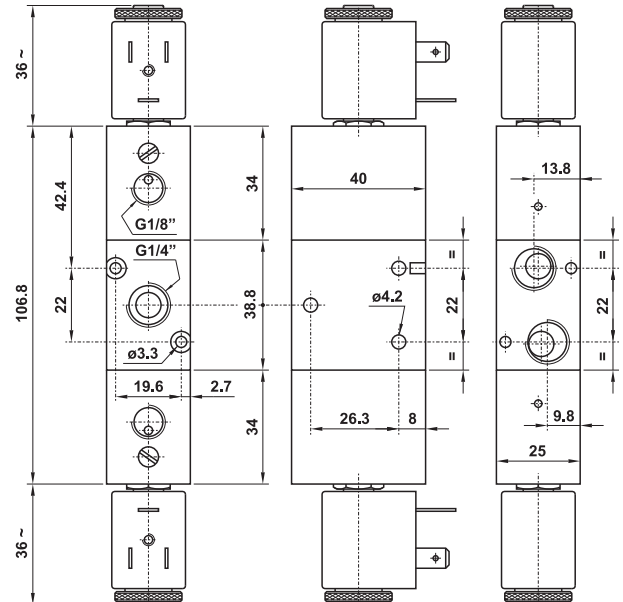

522 EE AS

5/2 1/4" doppio comando elettrico alimentazione separata

5/2 1/4" double solenoid pilot with separate air supply

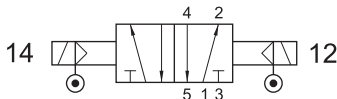

SOLO VERSIONE IN ALLUMINIO
ONLY ALUMINIUM VERSION

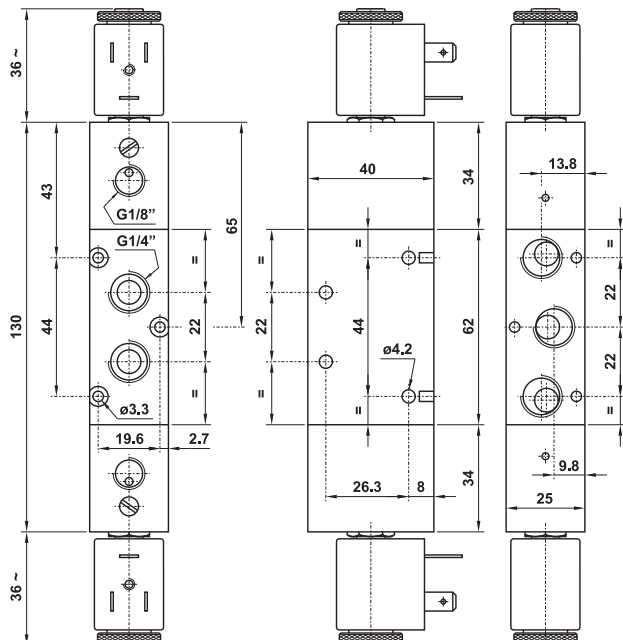

valvole ad azionamento elettropneumatico

solenoid actuated valves



5223C EE centri chiusi
closed centres

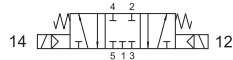

5223A EE centri aperti
open centres



5223P EE centri in pressione
pressurized centres

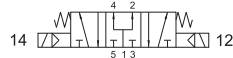

5/3 1/4" doppio comando elettrico

5/3 1/4" double solenoid pilot

SOLO VERSIONE IN ALLUMINIO
ONLY ALUMINIUM VERSION

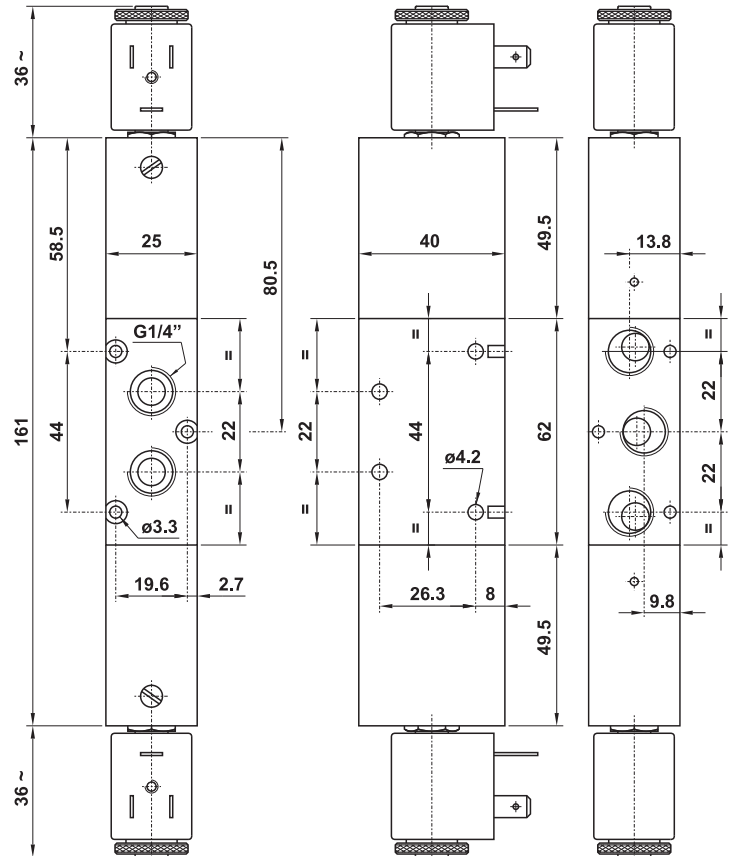

5223C EE AS centri chiusi
closed centres

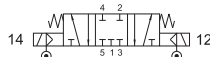

5223A EE AS centri aperti
open centres



5223P EE AS centri in pressione
pressurized centres

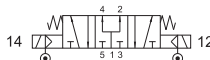

5/3 1/4" doppio comando elettrico alimentazione separata

5/3 1/4" double solenoid pilot with separate air supply

SOLO VERSIONE IN ALLUMINIO
ONLY ALUMINIUM VERSION

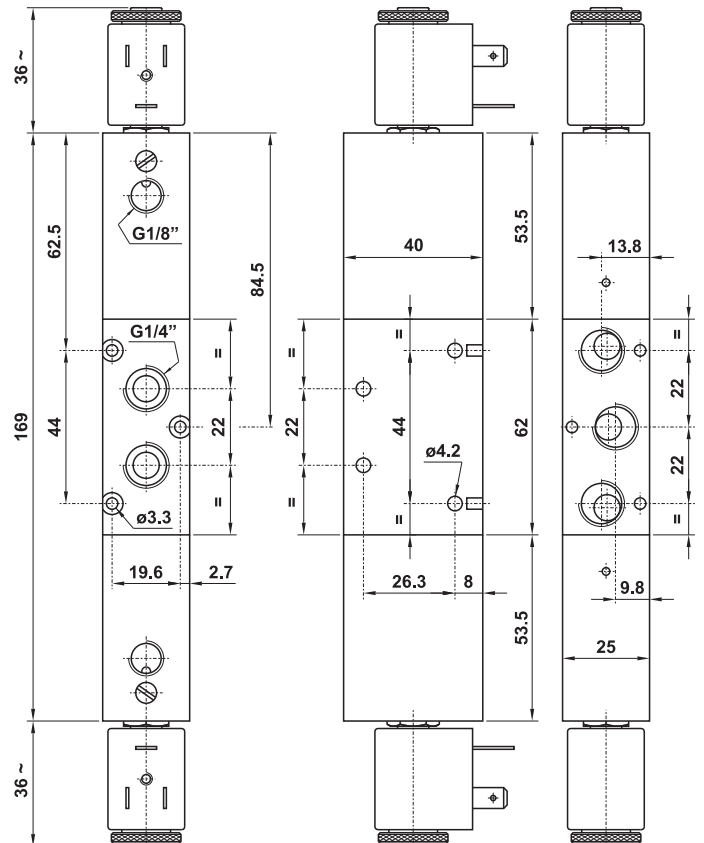

valvole ad azionamento elettropneumatico

solenoid actuated valves



322 MRE

3/2 1/4" NC comando elettrico - ritorno a molla RINFORZATA

3/2 1/4" NC solenoid pilot - REINFORCED spring return

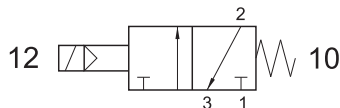

Non può essere utilizzata come valvola normalmente aperta.
It cannot be used as normally open valve.

Pressione di esercizio: 2.5 ... 10 bar

Working pressure: 2.5 ... 10 bar

La molla rinforzata permette un ritorno efficace della spola anche in assenza di aria.

The reinforced spring allows a prompt return of the spool also in lack of air.

Attenzione: il fondello per molla rinforzata è più lungo rispetto al fondello di una valvola con ritorno a molla normale.

Attention: the bottom end cap for reinforced spring return is longer than the end cap for normal spring return.

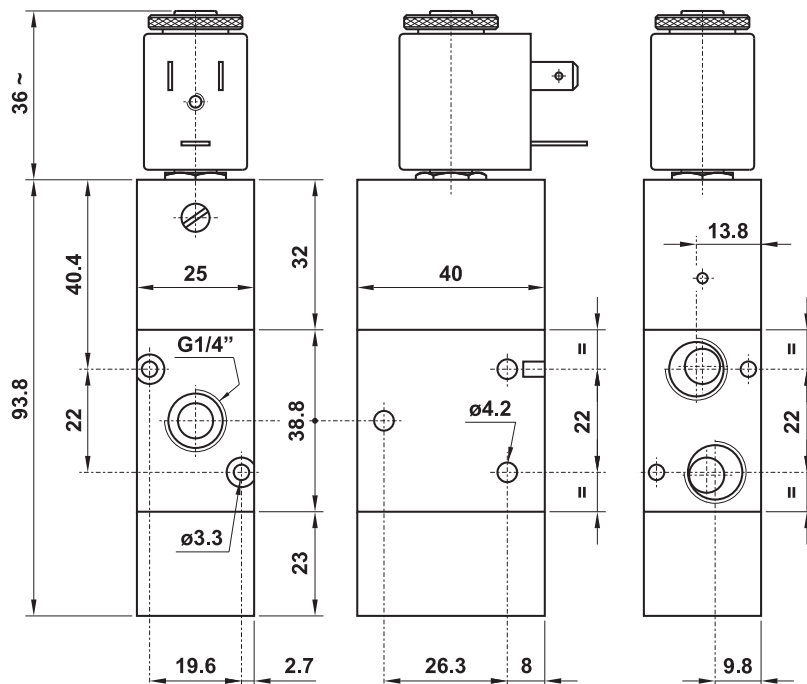

522 MRE

5/2 1/4" comando elettrico - ritorno a molla RINFORZATA

5/2 1/4" solenoid pilot - REINFORCED spring return

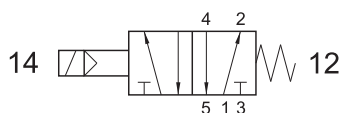

Pressione di esercizio: 2.5 ... 10 bar

Working pressure: 2.5 ... 10 bar

La molla rinforzata permette un ritorno efficace della spola anche in assenza di aria.

The reinforced spring allows a prompt return of the spool also in lack of air.

Attenzione: il fondello per molla rinforzata è più lungo rispetto al fondello di una valvola con ritorno a molla normale.

Attention: the bottom end cap for reinforced spring return is longer than the end cap for normal spring return.

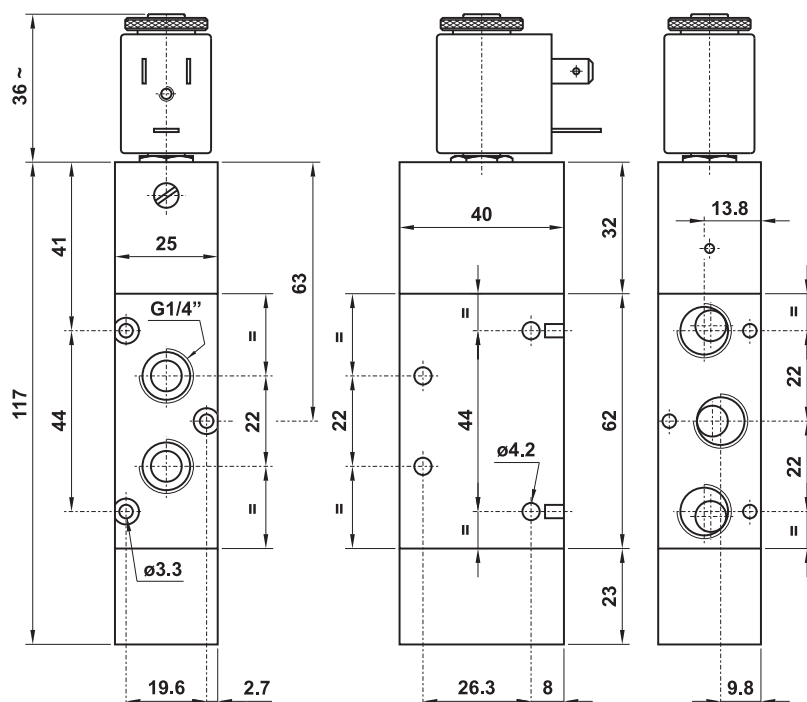

ricambi per valvole a spola

spare parts for spool valves

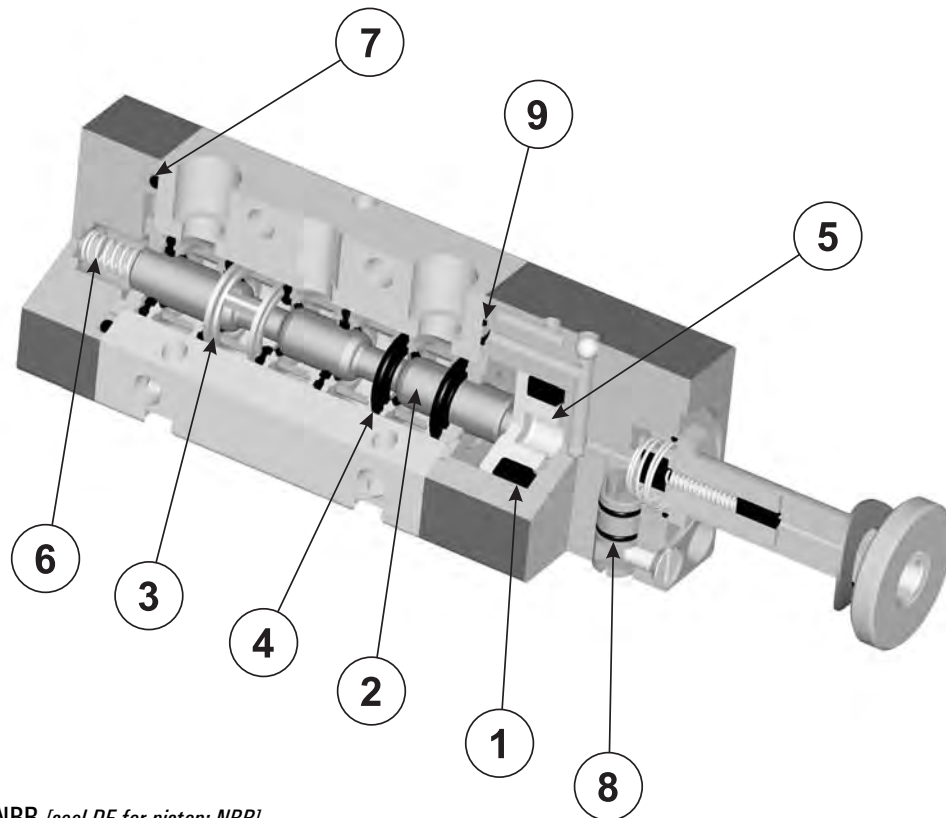

1. Guarnizione DE per pistone: NBR [seal DE for piston: NBR]
2. Spola: alluminio 11S nichelato [spool: aluminium 11S, nickeled]
3. Distanziale cassetto: ottone [brass]
4. Guarnizione cassetto: NBR [seal for spool: NBR]
5. Pistone per comando spola: delrin [piston to actuate the spool: delrin]
6. Molla: acciaio [spring: steel]
7. Guarnizione O-Ring: NBR
8. Guarnizione O-Ring 4x1: NBR
9. Guarnizione O-Ring sagomato: NBR [shaped O-Ring: NBR]

codice kit code of kit	utilizzabile per suitable for		
00.036.2	321 MC	321 MCA	321 ME
	321 MEA	321 ME90 S	321 ME90 L
00.039.2	521 MC	521 ME	521 ME90 S
	521 ME90 L		
00.037.2	321 CC	321 EE	321 CE
	321 EE AS	321 EE90 S	321 EE90 L
00.040.2	521 CC	521 EE	521 CE
	521 EE AS	521 EE90 S	521 EE90 L
01.014.2	322 MC	322 MC SUP	322 MCA
	322 ME	322 MEA	
01.020.2	522 MC	522 MC SUP	522 ME
01.015.2	322 CC	322 CC SUP	322 CE
	322 EE	322 EE AS	
01.021.2	522 CC	522 CC SUP	522 CE
	522 EE	522 EE AS	

codice kit code of kit	utilizzabile per suitable for		
00.038.2	321 EED	321 EFP	321 CCD
	321 CFP		
00.041.2	521 EED	521 EFP	521 CCD
	521 CFP		
01.019.2	322 EED	322 EFP	322 CCD
	322 CFP		
01.022.2	522 EED	522 EFP	522 CCD
	522 CFP		
00.050.2	321 ME AS		
01.035.2	322 ME AS		
00.051.2	521 ME AS		
01.036.2	522 ME AS		
00.108.2	5213C CC	5213A CC	5213P CC
	5213C EE	5213A EE	5213P EE
	5213C EE AS	5213A EE AS	5213P EE AS
01.061.2	5223C CC	5223A CC	5223P CC
	5223C EE	5223A EE	5223P EE
	5223C EE AS	5223A EE AS	5223P EE AS

bobine e connettori 22 mm

22 mm coils and connectors



22 mm



temperatura max di esercizio	+50°C	<i>max working temperature</i>
inserimento	ED 100%	<i>duty cycle</i>
protezione con connettore correttamente montato	IP 65	<i>protection with connector correctly mounted</i>
tolleranza di tensione	±10%	<i>tension tolerance</i>

- a richiesta basso assorbimento 24V DC 1.5W: **00.196.0**
low consumption (24V DC 1.5W) on request: 00.196.0

codice <i>code</i>	tensione <i>tension</i>	consumo - power	
		a regime <i>rated</i>	di spunto <i>inrush</i>
00.167.0	12V DC	3W	
00.028.0	24V DC	3W	
00.029.0	24V 50/60Hz	5VA	7.5VA
00.030.0	110V 50/60Hz	5VA	7.5VA
00.031.0	220V 50/60Hz	5VA	7.5VA

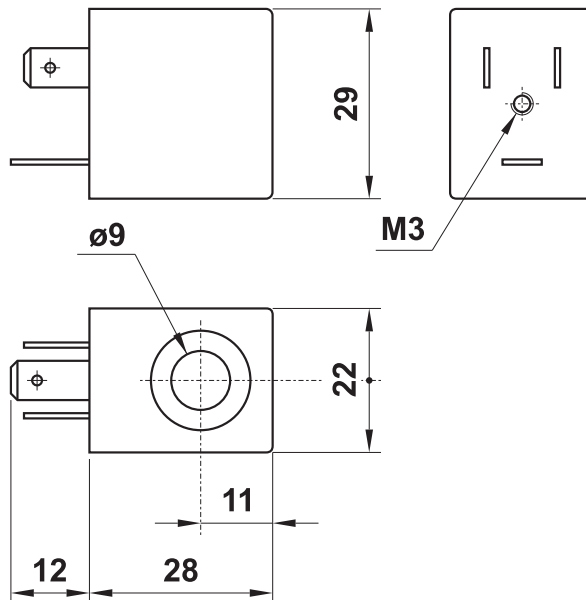

codice <i>code</i>	colore <i>colour</i>	cavo <i>cable</i>	tipo <i>type</i>
00.197.0	nero <i>black</i>	PG09	normale <i>standard</i>
00.344.0	trasparente <i>transparent</i>	PG09	con LED 24V <i>with LED 24V</i>
00.345.0	trasparente <i>transparent</i>	PG09	con LED 24V e VDR <i>with LED 24V and VDR</i>
00.346.0	trasparente <i>transparent</i>	PG09	con LED 115V <i>with LED 115V</i>
00.347.0	trasparente <i>transparent</i>	PG09	con LED 115V e VDR <i>with LED 115V and VDR</i>
00.394.0	trasparente <i>transparent</i>	PG09	con LED 230V <i>with LED 230V</i>
00.395.0	trasparente <i>transparent</i>	PG09	con LED 230V e VDR <i>with LED 230V and VDR</i>

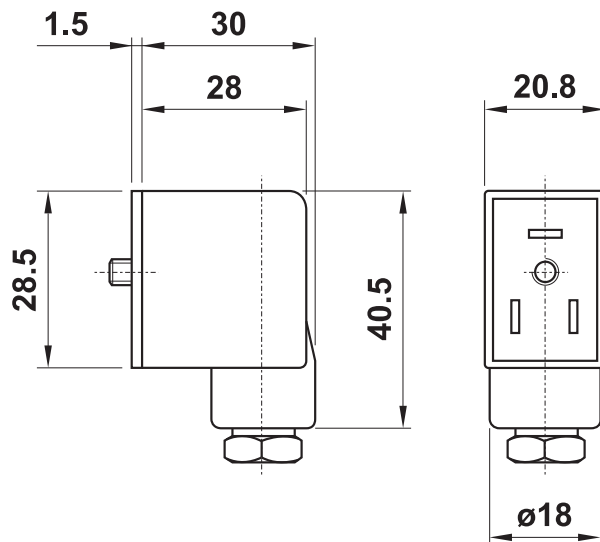

PEZZI DI RICAMBIO - spare parts

<p>canotto per elettropilota <i>armature for solenoid pilot</i></p> <p>NC : 00.088.0 NA (NO) : 00.306.0</p>	<p>ghiera in alluminio e rondella <i>aluminium nut and elastic ring</i></p> <p>00.125.2</p>
	<p>ghiera in plastica <i>nut in plastic material</i></p> <p>00.186.0</p>

valvole ad azion. elettropn. con sede sensore

solenoid actuated valves with slot for magnetic sensor



Modalità di funzionamento

Alle valvole ad azionamento elettropneumatico della serie 521 (G1/8") e 522 (G1/4") è stata aggiunta una sede per sensore magnetico che rileva la posizione della spola. Se la spola rimane in posizione azionata quando dovrebbe essere in posizione di riposo, il segnale restituito dal sensore può essere utilizzato ad esempio per comandare una valvola di messa a scarico dell'intero circuito o un segnale di allarme.

Possono essere utilizzati i sensori Hall PNP per cava a C (vedi pag. 660-661).

Non sono ammessi campi magnetici di disturbo in prossimità dei sensori.

Valve operation

To the solenoid actuated valves of the series 521 (G1/8") and 522 (G1/4"), a slot for magnetic sensor has been added. The magnetic sensor detects the position of the spool. If the spool remains in the actuated position when it should be in the idle position, the signal provided by the sensor can be used, for example, to control a quick exhaust valve for the entire circuit or to activate an alarm signal.

Hall PNP sensors for C-slot can be used (refer to page 660-661).
Disturbing magnetic fields near the sensors are not allowed.

Schema di montaggio sensori

Sensor assembling scheme

Sensore diritto per cava a C

Straight sensor for C-slot

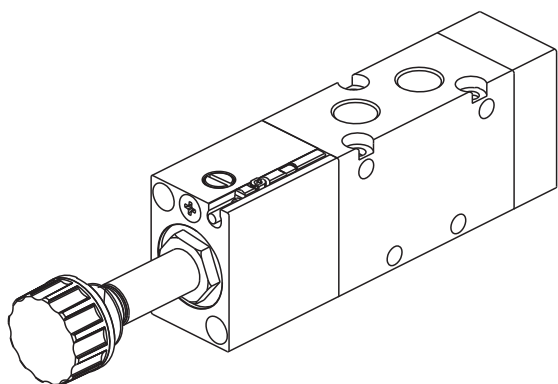
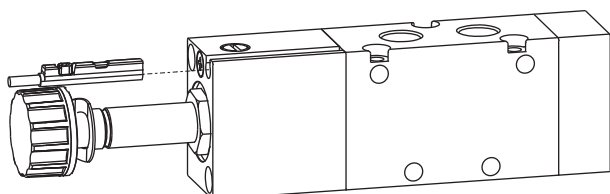

Sensori utilizzabili:

Usable sensors:

E3A-2C (26.547.0)

E3A-M8C (26.564.0)

Sensore a 90° per cava a C

90° sensor for C-slot

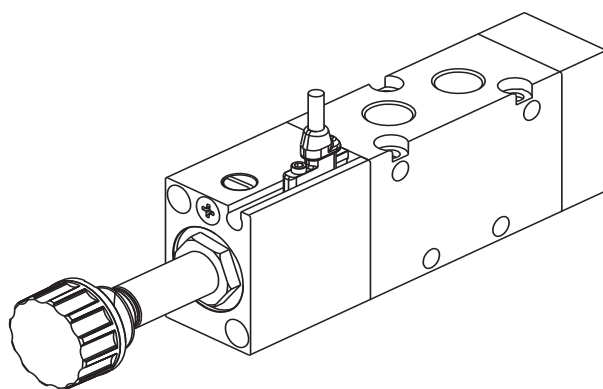
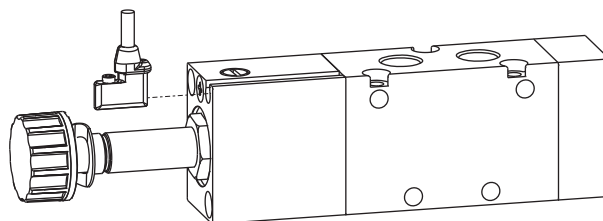

Sensori utilizzabili:

Usable sensors:

E3A90-M8C (26.548.0)

valvole ad azion. elettropn. con sede sensore

solenoid actuated valves with slot for magnetic sensor



321S ME

3/2 1/8" NC comando elettrico - ritorno a molla, con sede sensore
 3/2 1/8" NC solenoid pilot - spring return, with slot for magnetic sensor

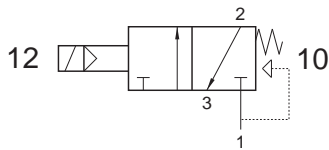

Non può essere utilizzata come valvola normalmente aperta.
It cannot be used as normally open valve.

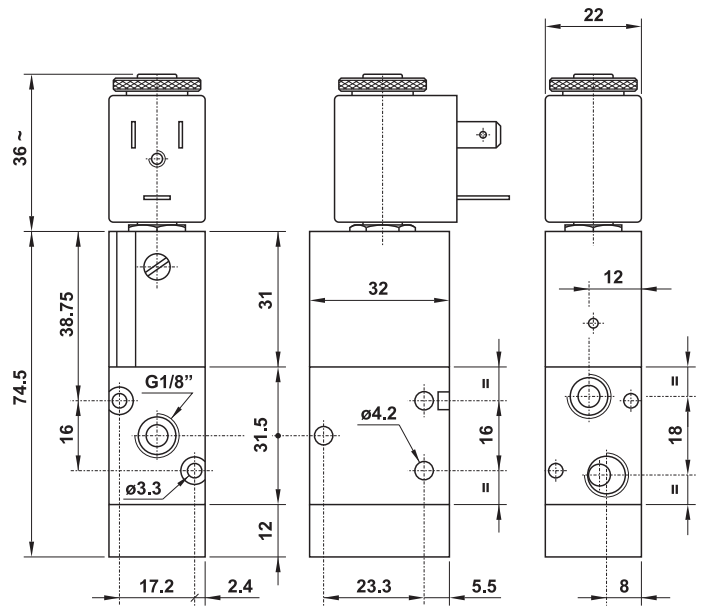
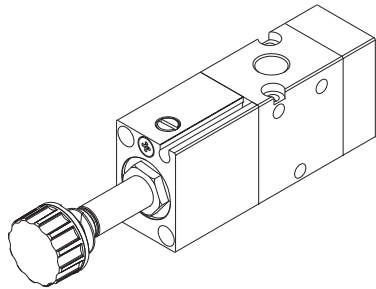

321S MRE

3/2 1/8" NC com. elettr. - ritorno a molla RINFORZATA, con sede sensore
 3/2 1/8" NC solenoid pilot - REINFORCED spring return, with slot for magnetic sensor

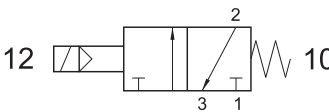

Non può essere utilizzata come valvola normalmente aperta.
It cannot be used as normally open valve.

Pressione di esercizio: 2.5 ... 10 bar

Working pressure: 2.5 ... 10 bar

La molla rinforzata permette un ritorno efficace della spola anche in assenza di aria.

The reinforced spring allows a prompt return of the spool also in lack of air.

Attenzione: il fondello per molla rinforzata è più lungo rispetto al fondello di una valvola con ritorno a molla normale.

Attention: the bottom end cap for reinforced spring return is longer than the end cap for normal spring return.

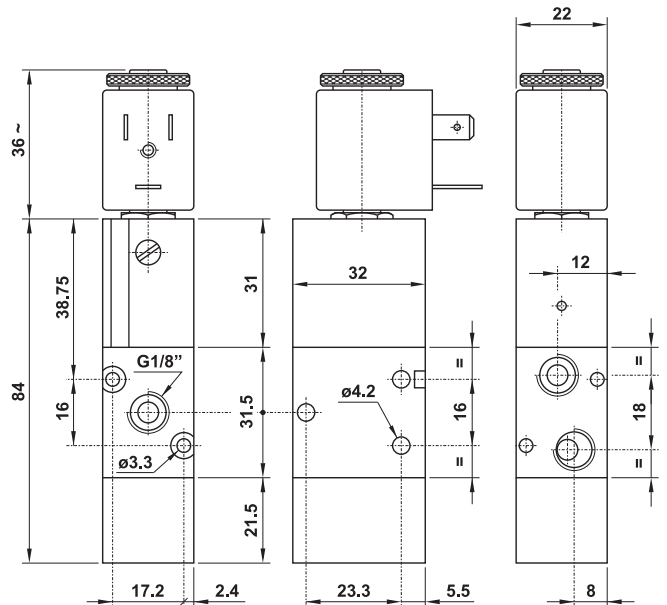

321S EE

3/2 1/8" doppio comando elettrico, con sede sensore
 3/2 1/8" double solenoid pilot, with slot for magnetic sensor

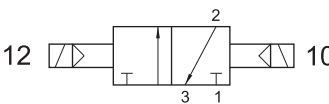

SOLO VERSIONE IN ALLUMINIO
 ONLY ALUMINIUM VERSION

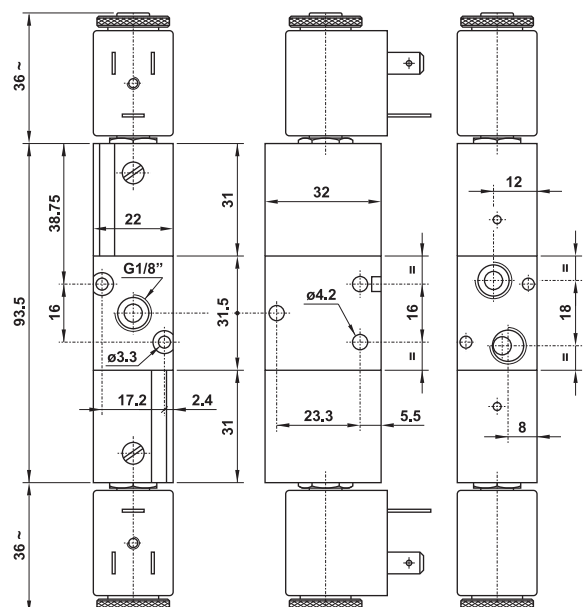
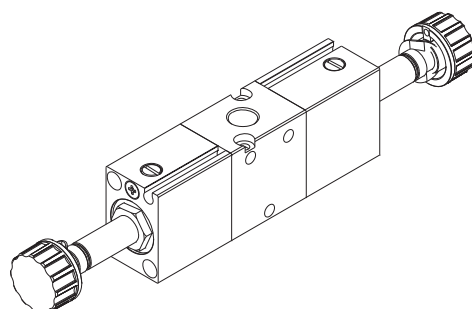

valvole ad azion. elettropn. con sede sensore

solenoid actuated valves with slot for magnetic sensor



521S ME

5/2 1/8" comando elettrico - ritorno a molla, con sede sensore

5/2 1/8" solenoid pilot - spring return, with slot for magnetic sensor

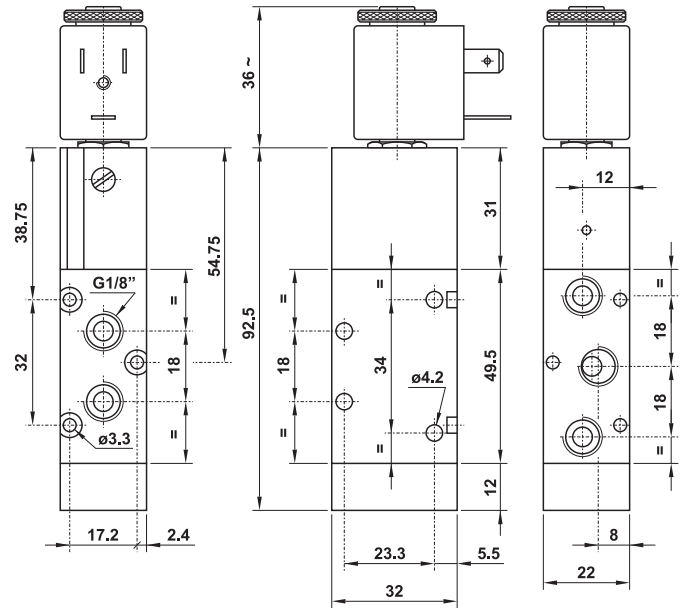
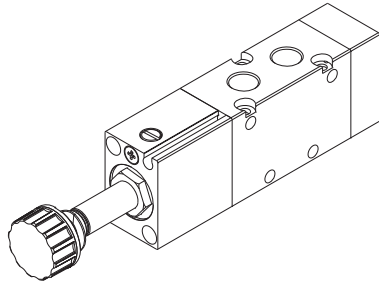
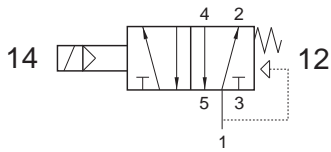

521S MRE

5/2 1/8" com. elettrico - ritorno a molla RINFORZATA, con sede sensore

5/2 1/8" solenoid pilot - REINFORCED spring return, with slot for magnetic sensor

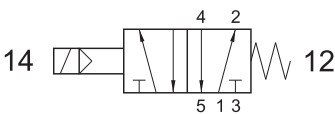

Pressione di esercizio: 2.5 ... 10 bar

Working pressure: 2.5 ... 10 bar

La molla rinforzata permette un ritorno efficace della spola anche in assenza di aria.

The reinforced spring allows a prompt return of the spool also in lack of air.

Attenzione: il fondello per molla rinforzata è più lungo rispetto al fondello di una valvola con ritorno a molla normale.

Attention: the bottom end cap for reinforced spring return is longer than the end cap for normal spring return.

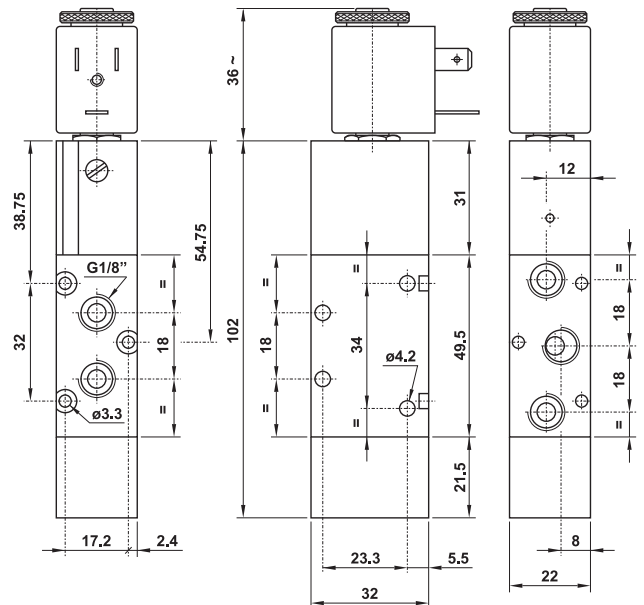

521S EE

5/2 1/8" doppio comando elettrico, con sede sensore

5/2 1/8" double solenoid pilot, with slot for magnetic sensor

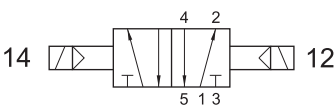

SOLO VERSIONE IN ALLUMINIO
ONLY ALUMINIUM VERSION

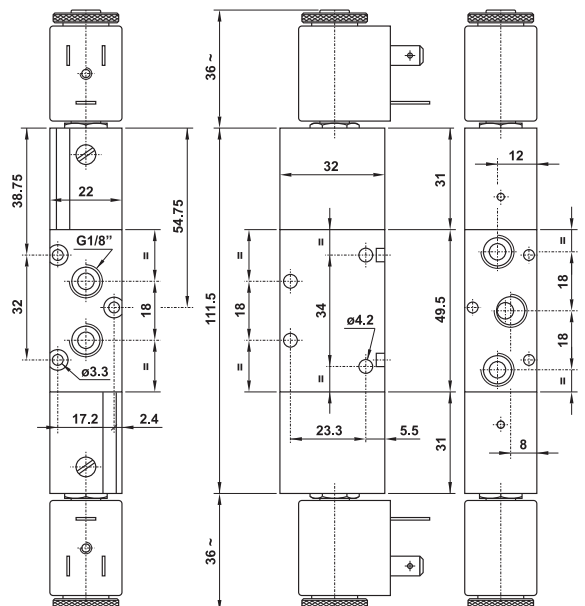
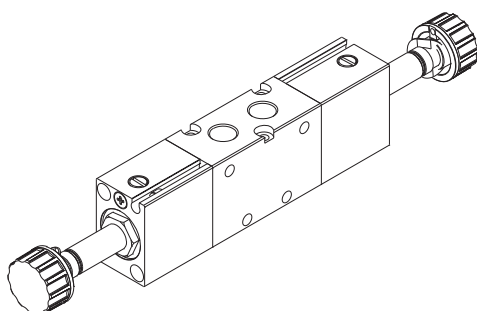

valvole ad azion. elettropn. con sede sensore

solenoid actuated valves with slot for magnetic sensor



322S ME

3/2 1/4" NC comando elettrico - ritorno a molla, con sede sensore
 3/2 1/4" NC solenoid pilot - spring return, with slot for magnetic sensor

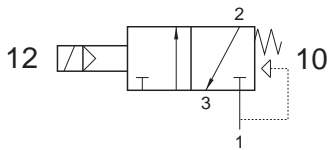

Non può essere utilizzata come valvola normalmente aperta.
It cannot be used as normally open valve.

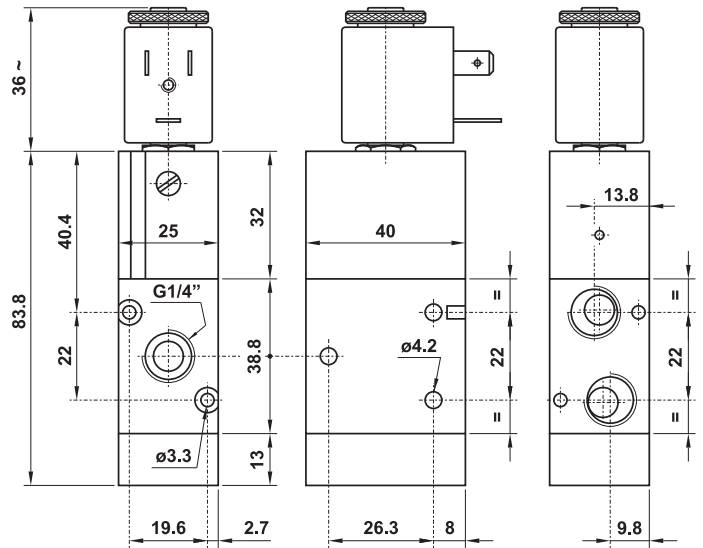
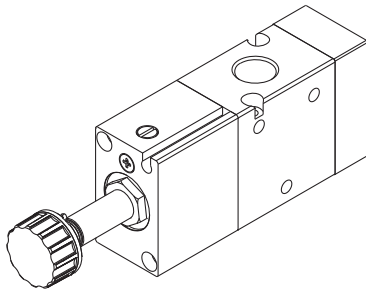

322S MRE

3/2 1/4" NC com. elettr. - rit. a molla RINFORZATA, con sede sensore
 3/2 1/4" NC solenoid pilot - REINFORCED spring return, with slot for magnetic sensor

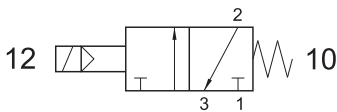

Non può essere utilizzata come valvola normalmente aperta.
It cannot be used as normally open valve.

Pressione di esercizio: 2.5 ... 10 bar

Working pressure: 2.5 ... 10 bar

La molla rinforzata permette un ritorno efficace della spola anche in assenza di aria.

The reinforced spring allows a prompt return of the spool also in lack of air.

Attenzione: il fondello per molla rinforzata è più lungo rispetto al fondello di una valvola con ritorno a molla normale.

Attention: the bottom end cap for reinforced spring return is longer than the end cap for normal spring return.

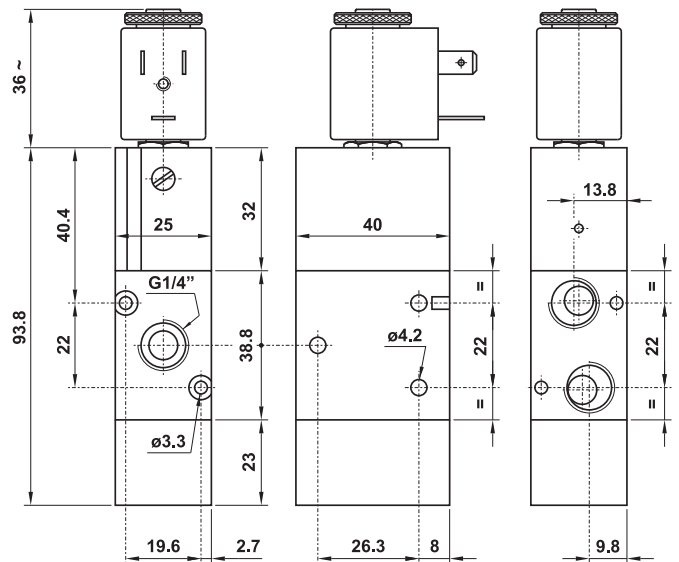

322S EE

3/2 1/4" doppio comando elettrico, con sede sensore
 3/2 1/4" double solenoid pilot, with slot for magnetic sensor

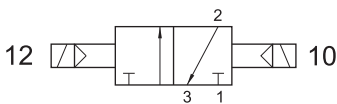

SOLO VERSIONE IN ALLUMINIO
 ONLY ALUMINIUM VERSION

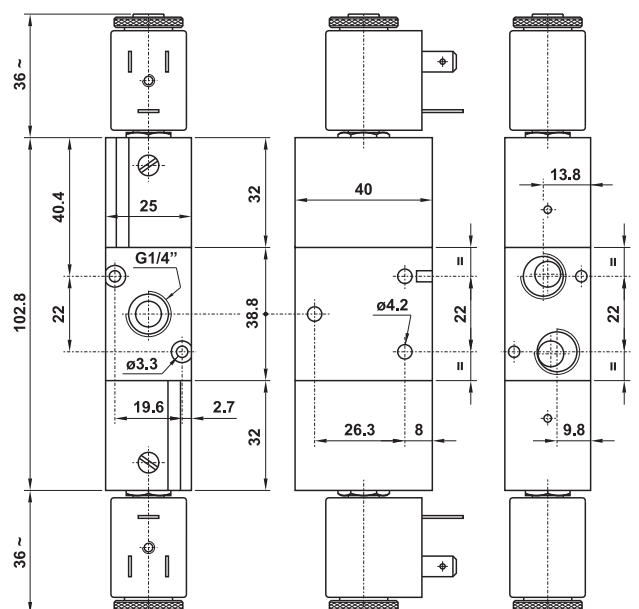
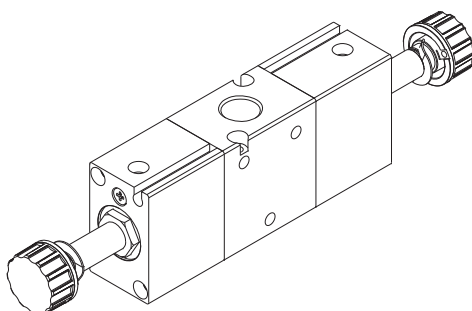

valvole ad azion. elettropn. con sede sensore

solenoid actuated valves with slot for magnetic sensor



522S ME

5/2 1/4" comando elettrico - ritorno a molla, con sede sensore

5/2 1/4" solenoid pilot - spring return, with slot for magnetic sensor

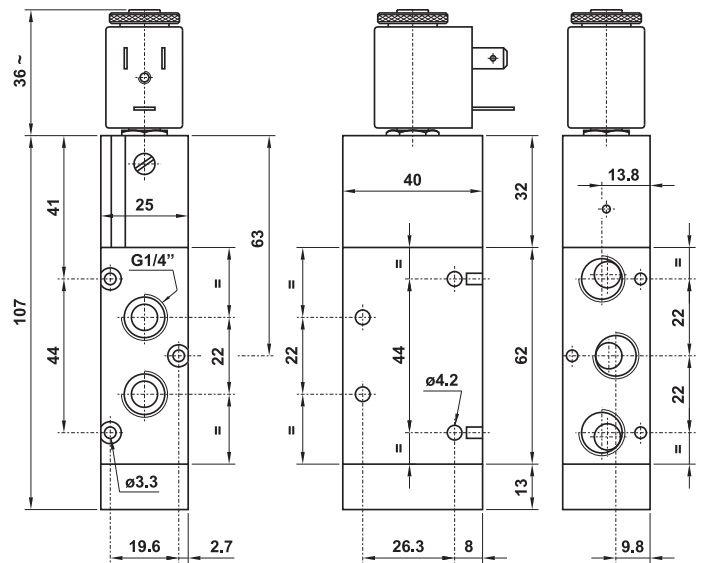
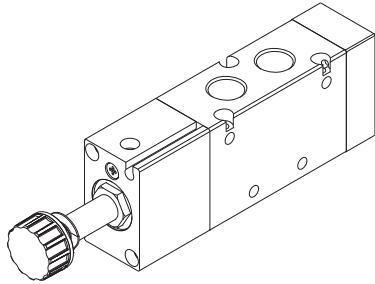
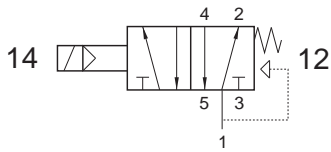

522S MRE

5/2 1/4" com. elettr. - ritorno a molla RINFORZATA, con sede sensore

5/2 1/4" solenoid pilot - REINFORCED spring return, with slot for magnetic sensor

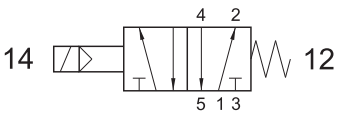

Pressione di esercizio: 2.5 ... 10 bar

Working pressure: 2.5 ... 10 bar

La molla rinforzata permette un ritorno efficace della spola anche in assenza di aria.

The reinforced spring allows a prompt return of the spool also in lack of air.

Attenzione: il fondello per molla rinforzata è più lungo rispetto al fondello di una valvola con ritorno a molla normale.

Attention: the bottom end cap for reinforced spring return is longer than the end cap for normal spring return.

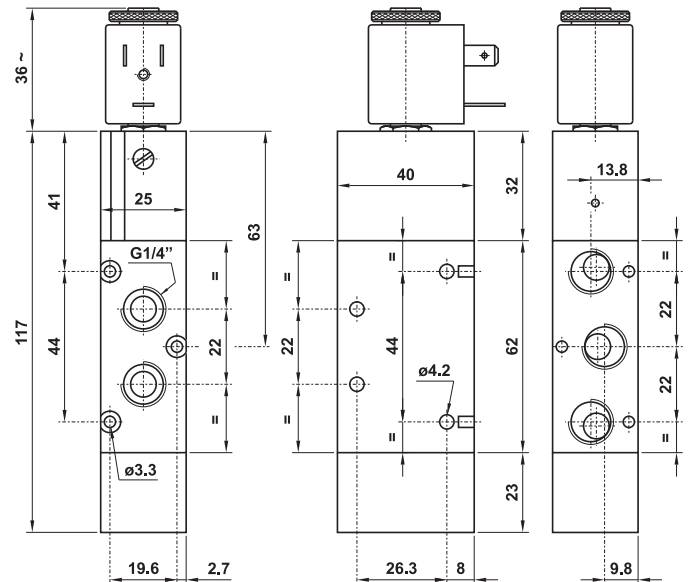

522S EE

5/2 1/4" doppio comando elettrico, con sede sensore

5/2 1/4" double solenoid pilot, with slot for magnetic sensor

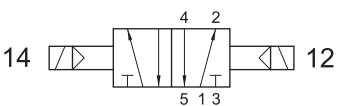

SOLO VERSIONE IN ALLUMINIO
ONLY ALUMINIUM VERSION

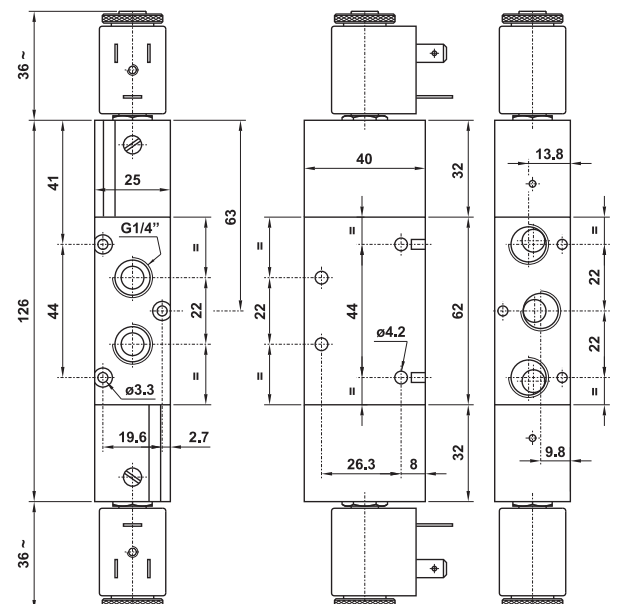
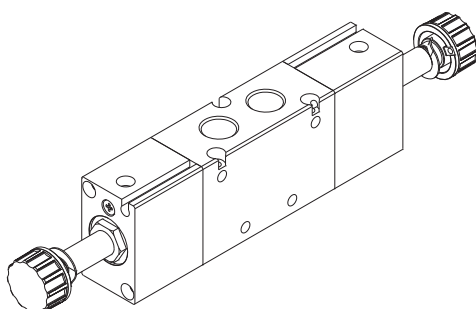

valvole ad azion. elettropn. con sede sensore

solenoid actuated valves with slot for magnetic sensor



582S ME

NAMUR

5/2 comando elettrico - ritorno a molla, con sede sensore

5/2 solenoid pilot - spring return, with slot for magnetic sensor

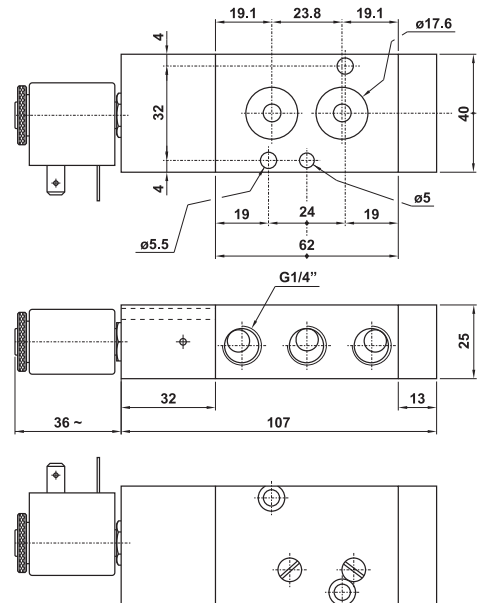
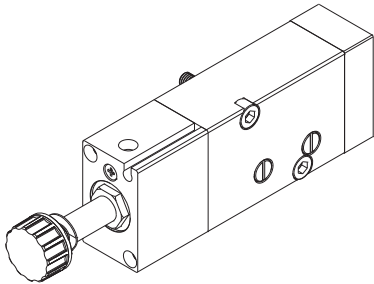
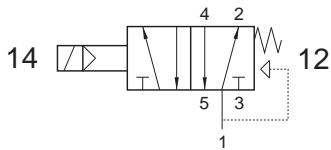

582S MRE

NAMUR

5/2 comando elettr. - ritorno a molla RINFORZATA, con sede sensore

5/2 solenoid pilot - REINFORCED spring return, with slot for magnetic sensor

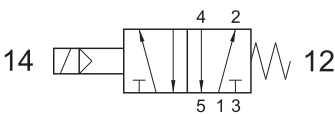

Pressione di esercizio: 2.5 ... 10 bar

Working pressure: 2.5 ... 10 bar

La molla rinforzata permette un ritorno efficace della spola anche in assenza di aria.

The reinforced spring allows a prompt return of the spool also in lack of air.

Attenzione: il fondello per molla rinforzata è più lungo rispetto al fondello di una valvola con ritorno a molla normale.

Attention: the bottom end cap for reinforced spring return is longer than the end cap for normal spring return.

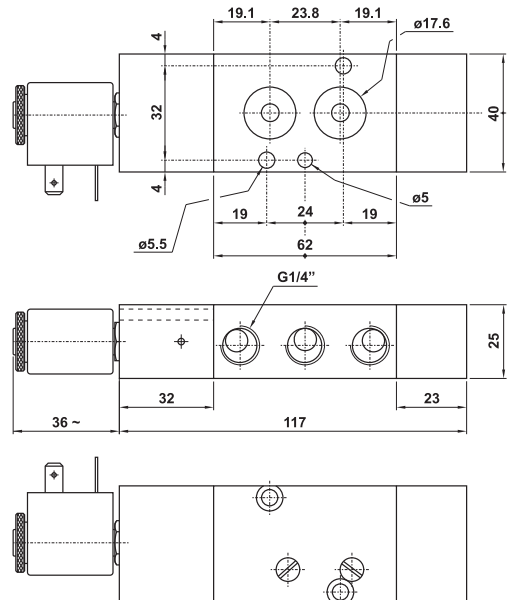

582S EE

NAMUR

5/2 doppio comando elettrico, con sede sensore

5/2 double solenoid pilot, with slot for magnetic sensor

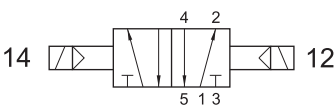

SOLO VERSIONE IN ALLUMINIO
ONLY ALUMINIUM VERSION

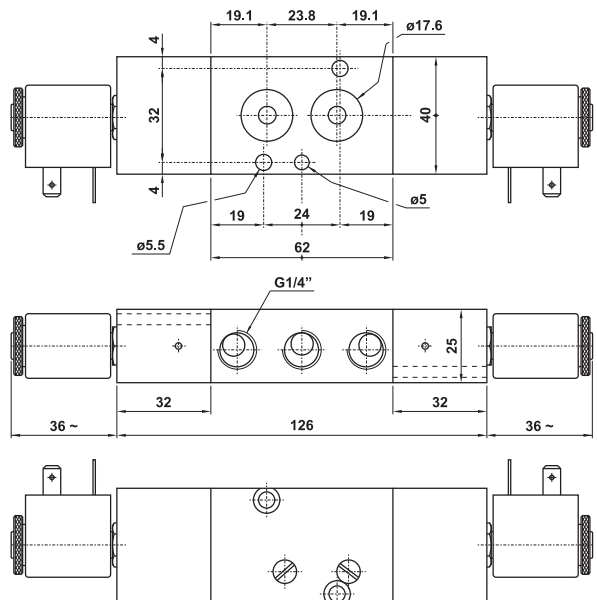
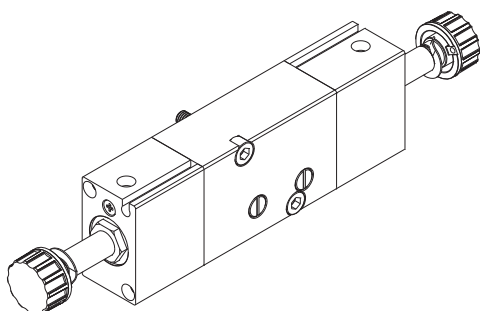

valvole ad azionamento elettropneumatico

solenoid actuated valves



321 ME MIC xx

3/2 1/8" NC comando elettrico con elettropilota 15 mm

3/2 1/8" NC with 15 mm solenoid pilot

La valvola è venduta con elettropilota/i montato/i (per i dati tecnici vedi pag. 221).
The valve is sold with mounted solenoid pilot(s); for technical data refer to page 221.

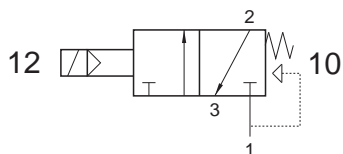

Non può essere utilizzata come valvola normalmente aperta.
It cannot be used as normally open valve.

Nella sigla del prodotto sostituire le lettere "xx" con l'indicazione della tensione.
In the part number replace "xx" with the reference of the solenoid tension.

24V DC 01
24V 50/60Hz 02

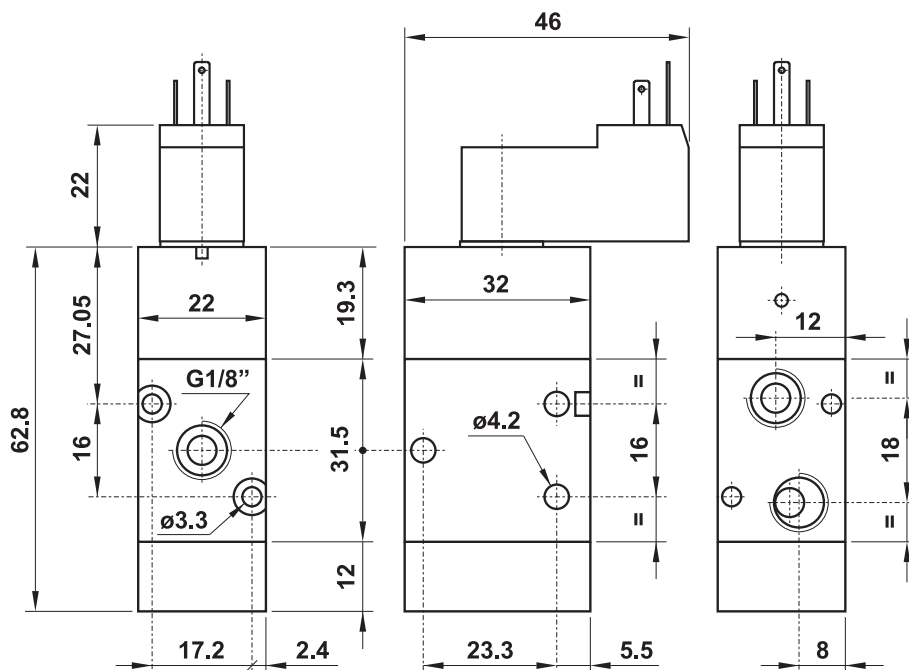

322 ME MIC xx

3/2 1/4" NC comando elettrico con elettropilota 15 mm

3/2 1/4" NC with 15 mm solenoid pilot

La valvola è venduta con elettropilota/i montato/i (per i dati tecnici vedi pag. 221).
The valve is sold with mounted solenoid pilot(s); for technical data refer to page 221.

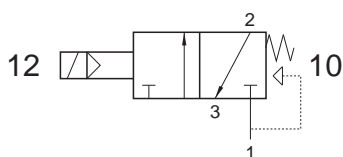

Non può essere utilizzata come valvola normalmente aperta.
It cannot be used as normally open valve.

Nella sigla del prodotto sostituire le lettere "xx" con l'indicazione della tensione.
In the part number replace "xx" with the reference of the solenoid tension.

24V DC 01
24V 50/60Hz 02

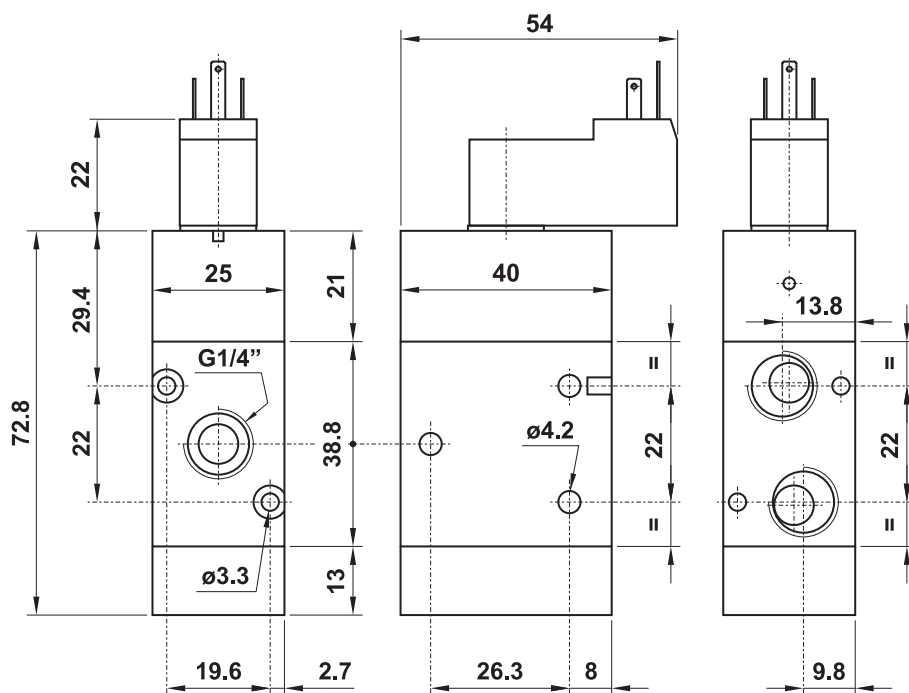

valvole ad azionamento elettropneumatico

solenoid actuated valves



321 EE MIC xx

3/2 1/8" doppio comando elettrico con elettropilota 15 mm
3/2 1/8" with double 15 mm solenoid pilot

La valvola è venduta con elettropilota/i montato/i (per i dati tecnici vedi pag. 221).
The valve is sold with mounted solenoid pilot(s); for technical data refer to page 221.

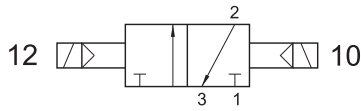

SOLO VERSIONE IN ALLUMINIO
ONLY ALUMINIUM VERSION

Nella sigla del prodotto sostituire le lettere "xx" con l'indicazione della tensione.
In the part number replace "xx" with the reference of the solenoid tension.

24V DC	01
24V 50/60Hz	02

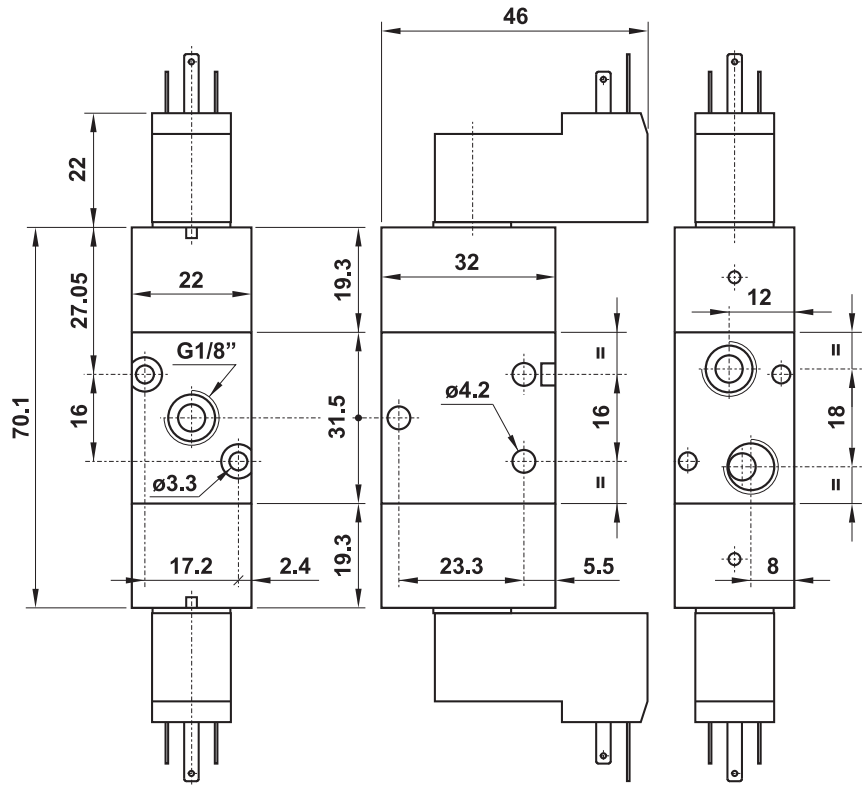

322 EE MIC xx

3/2 1/4" doppio comando elettrico con elettropilota 15 mm
3/2 1/4" with double 15 mm solenoid pilot

La valvola è venduta con elettropilota/i montato/i (per i dati tecnici vedi pag. 221).
The valve is sold with mounted solenoid pilot(s); for technical data refer to page 221.

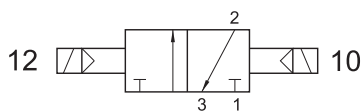

SOLO VERSIONE IN ALLUMINIO
ONLY ALUMINIUM VERSION

Nella sigla del prodotto sostituire le lettere "xx" con l'indicazione della tensione.
In the part number replace "xx" with the reference of the solenoid tension.

24V DC	01
24V 50/60Hz	02

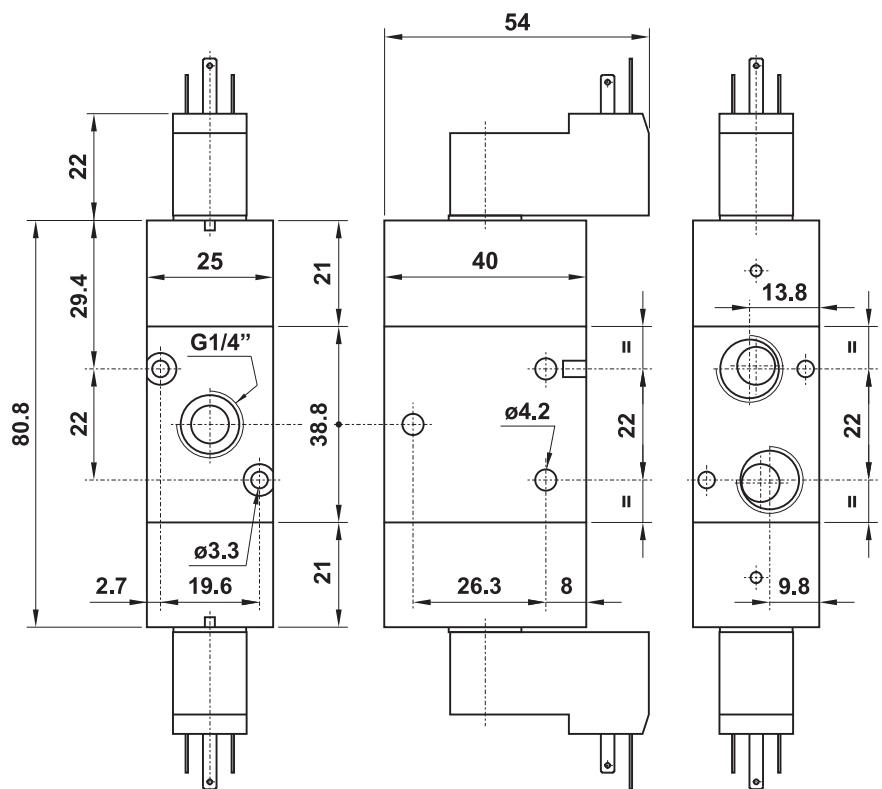
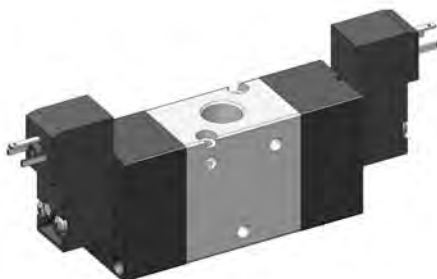

valvole ad azionamento elettropneumatico

solenoid actuated valves



521 ME MIC xx

5/2 1/8" comando elettrico con elettropilota 15 mm
5/2 1/8" with 15 mm solenoid pilot

La valvola è venduta con elettropilota/i montato/i (per i dati tecnici vedi pag. 221).
The valve is sold with mounted solenoid pilot(s); for technical data refer to page 221.

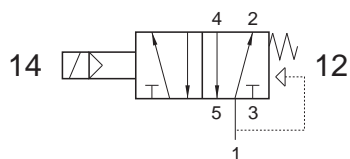

Nella sigla del prodotto sostituire le lettere "xx" con l'indicazione della tensione.
In the part number replace "xx" with the reference of the solenoid tension.

24V DC 01
24V 50/60Hz 02

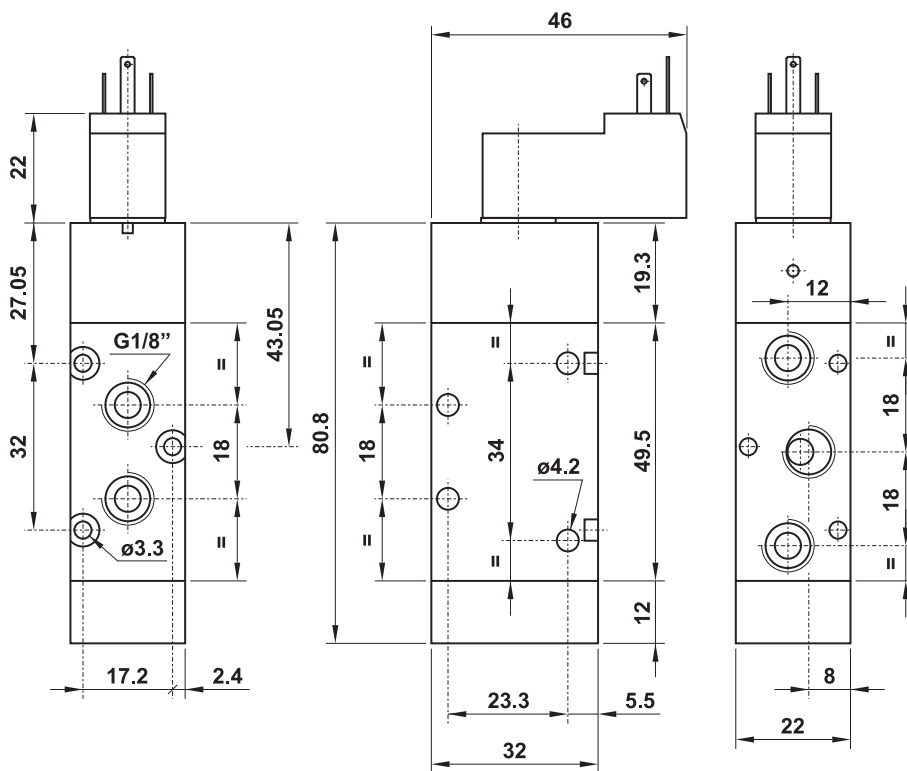

522 ME MIC xx

5/2 1/4" comando elettrico con elettropilota 15 mm
5/2 1/4" with 15 mm solenoid pilot

La valvola è venduta con elettropilota/i montato/i (per i dati tecnici vedi pag. 221).
The valve is sold with mounted solenoid pilot(s); for technical data refer to page 221.

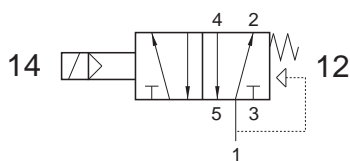

Nella sigla del prodotto sostituire le lettere "xx" con l'indicazione della tensione.
In the part number replace "xx" with the reference of the solenoid tension.

24V DC 01
24V 50/60Hz 02

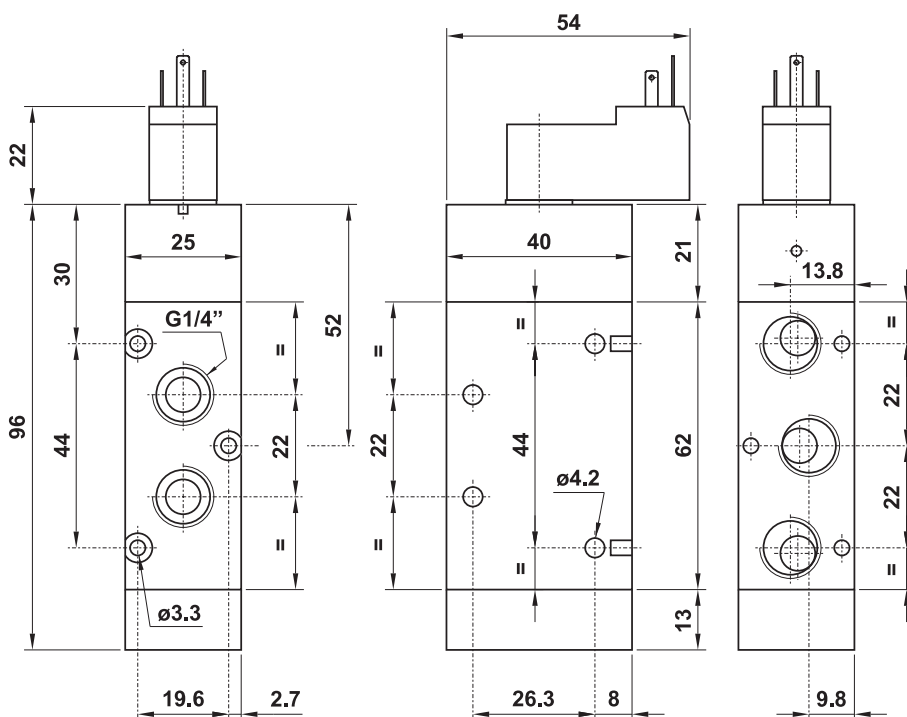

valvole ad azionamento elettropneumatico

solenoid actuated valves



521 EE MIC xx

5/2 1/8" doppio comando elettrico con elettropilota 15 mm
5/2 1/8" with double 15 mm solenoid pilot

La valvola è venduta con elettropilota/i montato/i (per i dati tecnici vedi pag. 221).
The valve is sold with mounted solenoid pilot(s); for technical data refer to page 221.

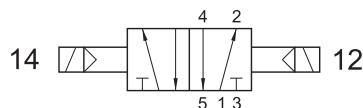

SOLO VERSIONE IN ALLUMINIO
ONLY ALUMINIUM VERSION

Nella sigla del prodotto sostituire le lettere "xx" con l'indicazione della tensione.
In the part number replace "xx" with the reference of the solenoid tension.

- | | |
|-------------|----|
| 24V DC | 01 |
| 24V 50/60Hz | 02 |

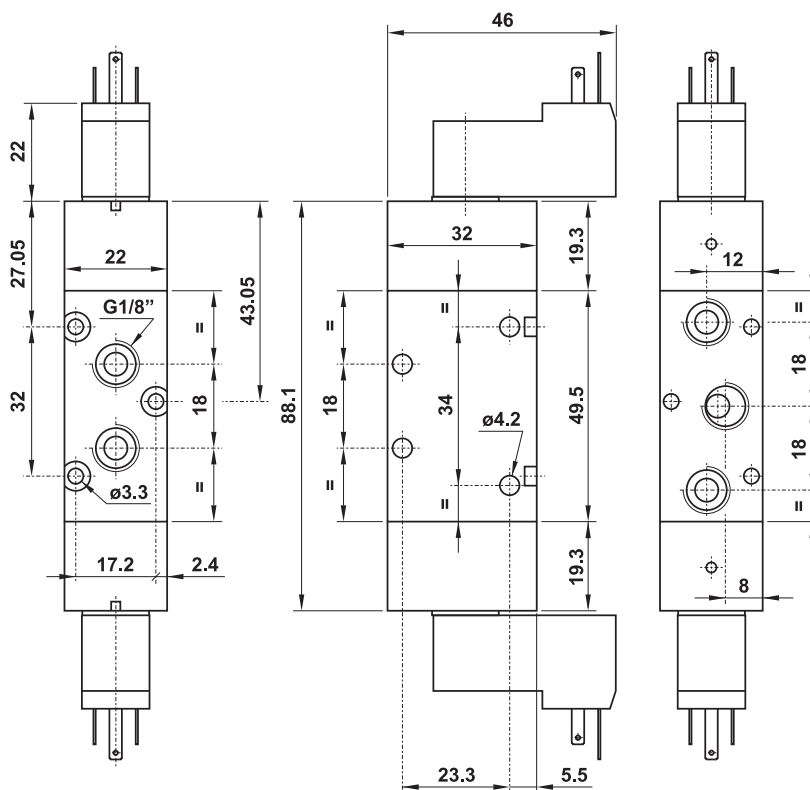

522 EE MIC xx

5/2 1/4" doppio comando elettrico con elettropilota 15 mm
5/2 1/4" with double 15 mm solenoid pilot

La valvola è venduta con elettropilota/i montato/i (per i dati tecnici vedi pag. 221).
The valve is sold with mounted solenoid pilot(s); for technical data refer to page 221.

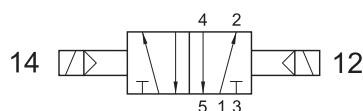

SOLO VERSIONE IN ALLUMINIO
ONLY ALUMINIUM VERSION

Nella sigla del prodotto sostituire le lettere "xx" con l'indicazione della tensione.
In the part number replace "xx" with the reference of the solenoid tension.

- | | |
|-------------|----|
| 24V DC | 01 |
| 24V 50/60Hz | 02 |

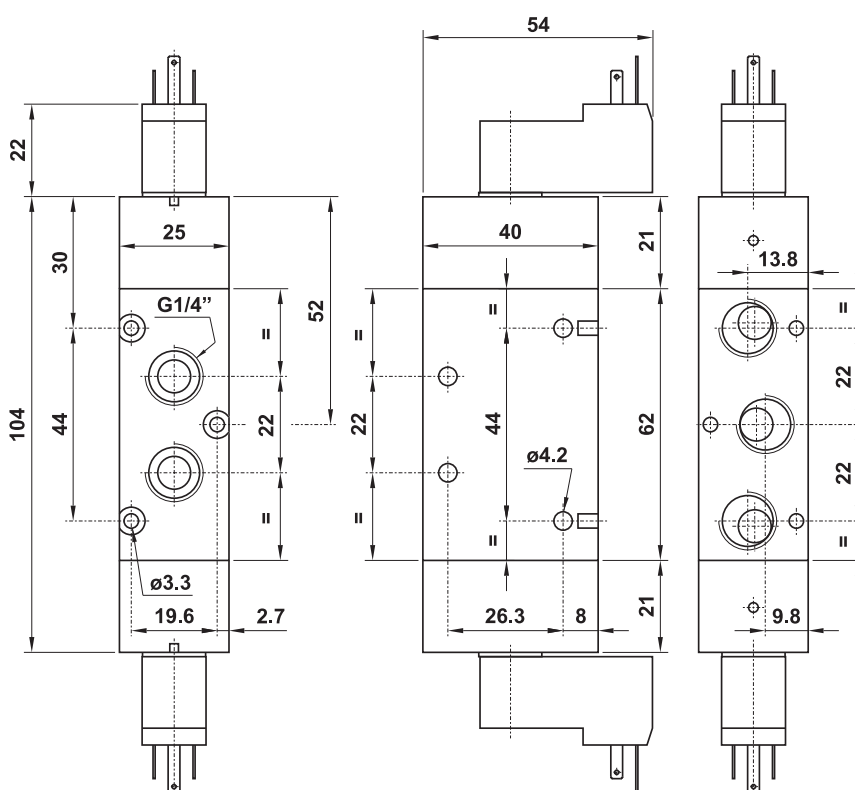

valvole ad azionamento elettropneumatico

solenoid actuated valves



5213C EE MIC xx centri chiusi
closed centres

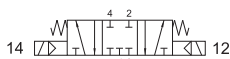

5213A EE MIC xx centri aperti
open centres

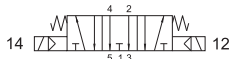

5213P EE MIC xx centri in pressione
pressurized centres

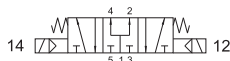

5/3 1/8" doppio comando elettrico con elettropilota 15 mm
5/3 1/8" with double 15 mm solenoid pilot

SOLO VERSIONE IN ALLUMINIO
ONLY ALUMINIUM VERSION

Nella sigla del prodotto sostituire le lettere "xx" con l'indicazione della tensione.
In the part number replace "xx" with the reference of the solenoid tension.

24V DC 01
24V 50/60Hz 02

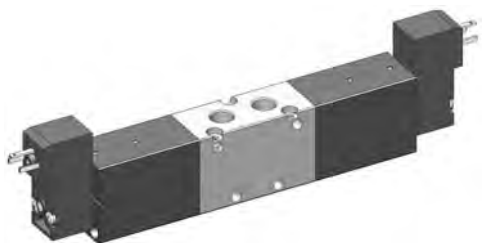

La valvola è venduta con elettropilota/i montato/i (per i dati tecnici vedi pag. 221).

The valve is sold with mounted solenoid pilot(s); for technical data refer to page 221.

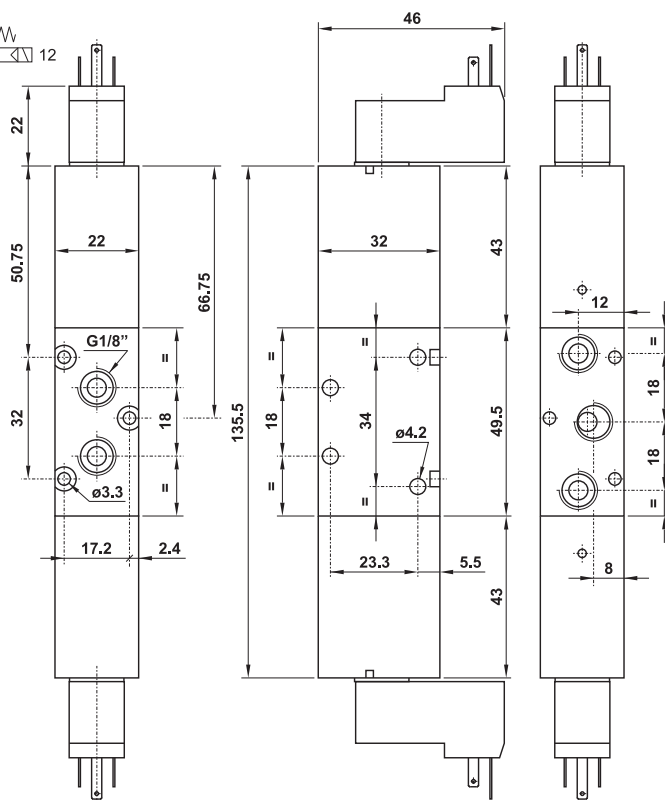

5223C EE MIC xx centri chiusi
closed centres

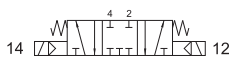

5223A EE MIC xx centri aperti
open centres



5223P EE MIC xx centri in pressione
pressurized centres

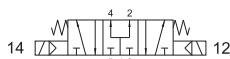

5/3 1/4" doppio comando elettrico con elettropilota 15 mm
5/3 1/4" with double 15 mm solenoid pilot

SOLO VERSIONE IN ALLUMINIO
ONLY ALUMINIUM VERSION

Nella sigla del prodotto sostituire le lettere "xx" con l'indicazione della tensione.
In the part number replace "xx" with the reference of the solenoid tension.

24V DC 01
24V 50/60Hz 02



La valvola è venduta con elettropilota/i montato/i (per i dati tecnici vedi pag. 221).

The valve is sold with mounted solenoid pilot(s); for technical data refer to page 221.

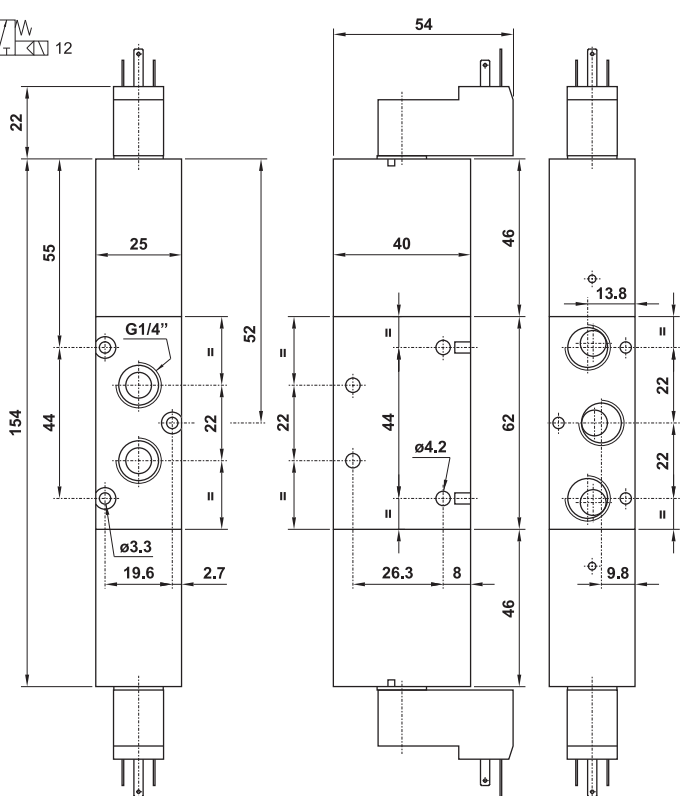

elettropiloti e connettori 15 mm

15 mm solenoids and connectors



15 mm

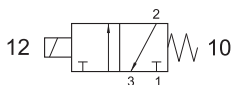

funzione della valvola	3/2 NC	valve function
diametro nominale	1.1 mm	nominal orifice
portata 1-2	30 NI/min	flow rate 1-2
portata 2-3	35 NI/min	flow rate 2-3
pressione di esercizio	max 10 bar	working pressure
durata cicli	100x10 ⁶	life time (cycles)
tempo di risposta	10 ms	response time
temperatura max di esercizio	+50°C	max working temperature
inserimento	ED 100%	duty cycle
consumo a regime	DC: 2W	rated power consumption
	AC: 1.3VA	
protezione	IP 51	protection
tolleranza di tensione	-10%; +15%	tension tolerance

- Connessione elettrica: DIN 43650 forma C
Electrical connection: DIN 43650, C form
- Con azionatore manuale monostabile
With non-detented manual override

ACCESSORI - accessories	
piastrina con guarnizione mounting plate with gasket	
00.414.0	
vite di fissaggio (sono necessarie 2 viti) mounting screw (2 screws are necessary)	
00.413.0	

codice code	tensione tension
00.253.0	12V DC
00.254.0	24V DC
00.255.0	24V 50/60Hz
00.256.0	110V 50/60Hz
00.257.0	220V 50/60Hz

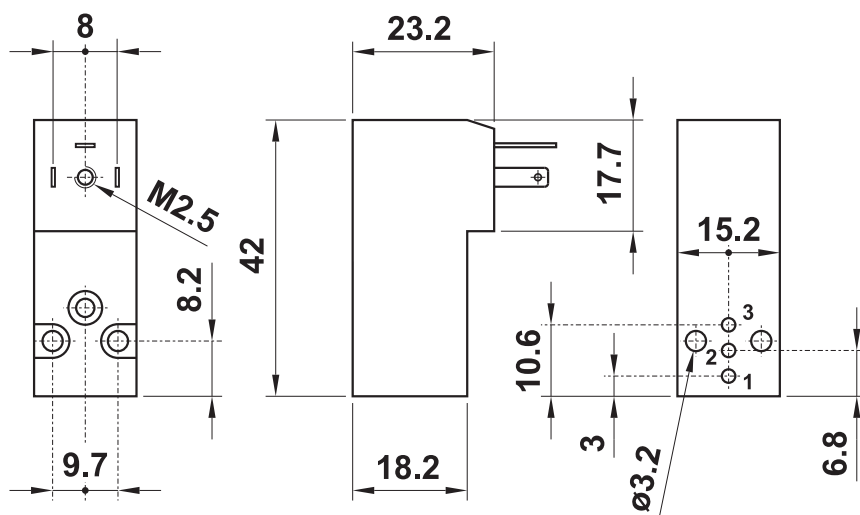

codice code	colore colour	cavo cable	tipo type
00.252.0	nero black	PG07	normale standard
00.341.0	trasparente transparent	PG07	con LED 24V e VDR with LED 24V and VDR
00.342.0	trasparente transparent	PG07	con LED 115V with LED 115V
00.343.0	trasparente transparent	PG07	con LED 115V e VDR with LED 115V and VDR
00.398.0	trasparente transparent	PG07	con LED 230V with LED 230V
00.399.0	trasparente transparent	PG07	con LED 230V e VDR with LED 230V and VDR

